

HEATHKIT[®] MANUAL

for the

FM DEVIATION METER

Model IM-4180

595-2174-01



HEATH COMPANY • BENTON HARBOR, MICHIGAN

HEATH COMPANY PHONE DIRECTORY

The following telephone numbers are direct lines to the departments listed:

Kit orders and delivery information (616) 982-3411
Credit (616) 982-3561
Replacement Parts (616) 982-3571

Technical Assistance Phone Numbers

8:00 A.M. to 12 P.M. and 1:00 P.M. to 4:30 P.M., EST, Weekdays Only
R/C, Audio, and Electronic Organs (616) 982-3310
Amateur Radio (616) 982-3296
Test Equipment, Weather Instruments and
Home Clocks (616) 982-3315
Television (616) 982-3307
Aircraft, Marine, Security, Scanners, Automotive,
Appliances and General Products (616) 982-3496
Computers (616) 982-3309

YOUR HEATHKIT 90 DAY LIMITED WARRANTY

If you are not satisfied with our service - warranty or otherwise - or with our products, write directly to our Director of Customer Services, Heath Company, Benton Harbor, Michigan 49022. He will make certain your problems receive immediate, personal attention.

Our attorney, who happens to be quite a kitbuilder himself, insists that we describe our warranty using all the necessary legal phrases in order to comply with the new warranty regulations. Fine. Here they are:

For a period of ninety (90) days after purchase, Heath Company will replace or repair free of charge any parts that are defective either in materials or workmanship. You can obtain parts directly from Heath Company by writing us at the address below or by telephoning us at (616) 982-3571. And we'll pay shipping charges to get those parts to you — anywhere in the world.

We warrant that during the first ninety (90) days after purchase, our products, when correctly assembled, calibrated, adjusted and used in accordance with our printed instructions, will meet published specifications.

If a defective part or error in design has caused your Heathkit product to malfunction during the warranty period through no fault of yours, we will service it free upon proof of purchase and delivery at your expense to the Heath factory, any Heathkit Electronic Center (units of Schlumberger Products Corporation), or any of our authorized overseas distributors.

You will receive free consultation on any problem you might encounter in the assembly or use of your Heathkit product. Just drop us a line or give us a call. Sorry, we cannot accept collect calls.

Our warranty does not cover and we are not responsible for damage caused by the use of corrosive solder, defective tools, incorrect assembly, misuse, fire, or by unauthorized modifications to or uses of our products for purposes other than as advertised. Our warranty does not include reimbursement for customer assembly or set-up time.

This warranty covers only Heathkit products and is not extended to allied equipment or components used in conjunction with our products. **We are not responsible for incidental or consequential damages.** Some states do not allow the exclusion or limitation of incidental or consequential damages, so the above limitation or exclusion may not apply to you. This warranty gives you specific legal rights, and you may also have other rights which vary from state to state.

HEATH COMPANY
BENTON HARBOR, MI. 49022

Prices and specifications subject to change without notice.

Heathkit[®] Manual

for the

FM DEVIATION METER

Model IM-4180

595-2174-01

HEATH COMPANY
BENTON HARBOR, MICHIGAN 49022

Copyright © 1978
Heath Company
All Rights Reserved
Printed in the United States of America



INITIAL TESTS

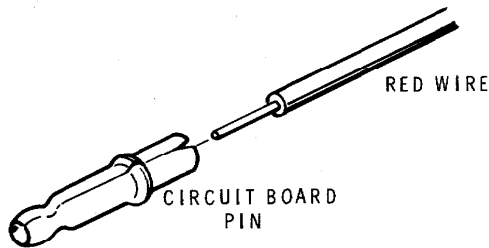

PICTORIAL 5-1

Refer to Pictorial 5-1 for the following steps.

- (✓) Prepare both ends of the remaining red wire.
- (✓) Push a male circuit board pin onto one end of the wire as shown. Solder the connector to the wire. The wire will be used for tests in the following steps.

NOTE: In any of the following steps in this section, or in "Calibration" or in the "Alignment" sections, when a jumper wire is referred to, for example, a "blue jumper wire" or a "red jumper wire," it means you should locate and connect one of the jumper wires (with a female connector) to a male connector pin on the circuit board.

Refer to Pictorials 5-2 and 5-3 (Illustration Booklet, Page 9) for the following steps.

- (✓) Connect the male pin on the end of the red test wire into the female connector on the end of the green jumper wire.
- (✓) Connect the battery clip on the main circuit board to the battery case if you are using batteries; if you are going to use the Battery Charger/Eliminator Accessory, connect the small plug on that unit into J101 on the main circuit board. Make sure the AC line cord is plugged into an AC outlet.

If you have installed **rechargeable batteries**, set switch SW102 at CHARGE; the switch position, otherwise, **must** be set to NO CHARGE.

- (✓) On the front panel, press the RED ON-OFF switch to its OFF position (out).
- (✓) Check the position of the meter pointer. If the pointer is not exactly over the scale "0," turn the mechanical adjust screw (directly under the center of the meter) until it is **one pointer width** below "0."

- () On the main circuit board connect the five remaining jumper wires as follows:

Yellow jumper wire to NORM.

Orange jumper wire to NORM.

Blue jumper wire to NORM.

Violet jumper wire to NORM.

Red jumper wire to NORM.

NOTE: In the following tests, if you fail to obtain the desired results, push the ON-OFF PUSHBUTTON to OFF (out) and refer to the "In Case of Difficulty" section on Page 51.

- (✓) Set the front panel controls as follows:
 - ✓ AUDIO LEVEL: Counterclockwise, but **not** OFF.
 - ✓ ON-OFF switch: ON (In).
 - BATT switch: Pushed in.

- (✓) Touch the end of the red test wire to the **15V** pin near U108. Check the meter lower scale for a reading between 10 and 15.
- (✓) Touch the red test wire to the **8V** pin near U108. Check the meter for an upscale reading. As you hold the wire on the **8V** pin, adjust 8V ADJ control R186 to obtain a reading of approximately 7.5 on the lower meter scale.
- () Push the ON-OFF switch to OFF.

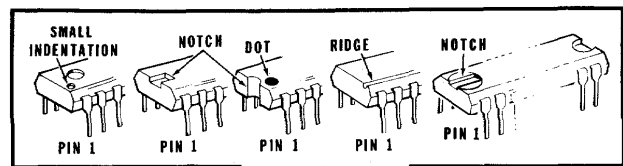

Detail 5-3A

- (✓) U107: Refer to Detail 5-3A and identify the pin 1 end of the TBA820L (#442-610) integrated circuit. Be sure the pins are straight on the IC; then match the pin 1 end of the IC with the index mark on the circuit board and carefully push the IC into socket U107 as shown.

- (✓) Push the ON-OFF switch to ON.
- (✓) Carefully touch the end of the red test wire to pin 14 of U107. Check the meter for a reading of approximately 10-14 on the bottom scale.
- (✓) Push the ON-OFF switch to OFF.

CAUTION: When you install the protected ICs, be sure they do not get damaged by static electricity. Once you remove the foam pad from the IC, DO NOT let go of the IC. Install the IC as follows. Read the entire step before you pick up the IC.

1. Pick up the IC and the foam pad with both hands.
2. Hold the IC with one hand and remove the foam pad with the other hand.
3. Continue to hold the IC one hand and straighten any bent pins with the other hand.
4. Pick up the circuit board in the other hand.
5. Align the tab of the IC with the index mark on the circuit board.
6. Then push the IC pins into the IC socket. Once in the socket, the IC is protected.

Refer to Detail 5-3B for the following five steps.

NOTE: Integrated circuits U101 through U106 are identical, and the method for installing and testing each of them also. You will be instructed how to install and test U101; install and test U102 through U106 in exactly the same manner.

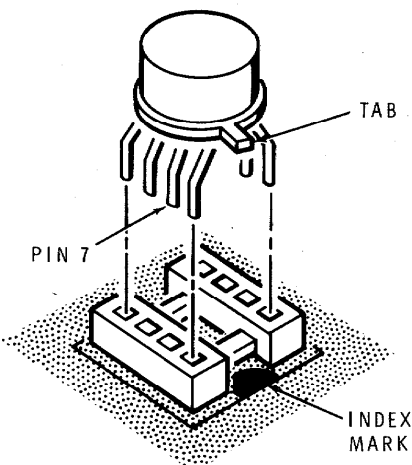

Detail 5-3B

- (✓) U101: Make sure the leads of a CA3130S integrated circuit (#442-623) are straight. Carefully position the tab on the IC toward the index end of the IC socket; then push the IC leads into the socket pins.

- (✓) Push the ON-OFF switch to ON.
- (✓) Turn the AUDIO LEVEL control clockwise until it just clicks ON.

NOTE: To avoid possible damage to the IC, touch only the designated lead in the following step.

- (✓) Locate pin 7 of U101. Carefully touch the end of the red test wire to pin 7 and check for a meter reading of 4.5 to 7.0 on the bottom meter scale.

- (✓) Push the ON-OFF switch to OFF.

- () U102 through U106: As with IC U101, install and test five CA3130S integrated circuits (#442-623). Be sure the Deviation Meter is turned OFF as you install each IC. Be very careful to always position the tab on the IC toward the index mark on the circuit board. NOTE: The Meter readings for each IC (on the bottom scale) is as follows:

U102: 5.5 to 8.2 7¹

U103: 6.0 to 9.0 7

U104: 5.0 to 8.0 6.5

U105: 5.0 to 8.0 7.2

U106: 6.0 to 9.0 7

- (✓) When you have installed and tested integrated circuits U101 through U106, push the ON-OFF switch to its OFF position.

- (✓) Remove the red test wire from the green jumper wire. Push the green jumper wire onto the 8V circuit board pin.

This completes the "Initial Tests;" proceed to "Alignment and Calibration."



ALIGNMENT AND CALIBRATION

CONVERTER CIRCUIT BOARD ALIGNMENT

Refer to Pictorials 5-2 and 6-1 (Illustration Booklet, Page 9) as you perform the following steps.

(✓) Connect the battery case and (or) Battery Charger/Eliminator Accessory as outlined in the "Initial Tests" on Page 41.

(✓) Set the front panel controls as follows:

ON-OFF switch: OFF.

BATT switch: In.

(✓) On the main circuit board, connect all five jumper wires (except the green jumper) to their adjacent NORM connector pins.

(✓) On the front panel, check the meter (**not** frequency dial) pointer. It should indicate **one pointer width** (thickness) below the "0" index at the left of the scale. If it does not, adjust the mechanical adjust screw in either direction for the correct pointer position.

(✓) Connect the green wire jumper to the circuit board 8V pin.

(✓) Push the ON-OFF switch to ON.

(✓) Turn 8V ADJ control R186 with the trimmer alignment tool for a reading of exactly 7.5 on the 0-20 scale.

(✓) Push the ON-OFF switch to OFF.

(✓) Disconnect the green jumper wire from the 8V pin and push it onto the 15V circuit board pin.

(✓) Slightly push in on the TUNE switch to release the BATT switch to its out position.

NOTE: To align the Deviation Meter local oscillator, you may use either of the following methods. Using the first method, you will need a frequency counter capable of covering from 25 MHz to 50 MHz. The second method will require a standard FM broadcast receiver. Proceed to the one procedure below that you prefer.

Alignment Using Frequency Counter

(✓) Connect the RF Input jack on the Deviation Meter to the input jack of a frequency counter.

(✓) Set the frequency dial pointer to 25 on the upper Deviation Meter scale. Set the frequency counter to measure 25 MHz.

IMPORTANT: Some frequency meters may indicate exact multiples of $2\times$ or $3\times$ the fundamental frequency.

(✓) Turn the FINE TUNE control to align the pointer with the line at approximately 2 o'clock on the front panel.

(✓) Push the ON-OFF switch to ON.

Refer to Pictorial 6-1 for the following steps.

NOTE: You will be instructed to adjust coil L202 and trimmer C211 in the following steps. Use the coil alignment tool and adjust L202 through the converter shield hole marked "LO." Adjust trimmer C211 with the trimmer alignment tool through the shield hole marked "HI."

Adjust coil L202 and trimmer C211 as follows:

(✓) 1. Adjust L202 (LO) for a reading of 25 (MHz) on the frequency counter.

(✓) 2. Turn the Deviation Meter dial pointer to 50.

(✓) 3. Adjust trimmer C211 (HI) to produce a frequency counter reading of 50 (MHz).

NOTE: If you cannot adjust capacitor C211 to at least 49.9 MHz at the high frequency end, refer to "High Frequency Adjustment" on Page 44.

(✓) 4. Turn the Deviation meter dial to 25. Readjust L202 for a counter reading of 25.

(✓) 5. Repeat Steps 1 through 4 until no further improvement can be made.

(✓) Push the ON-OFF switch to OFF.

(✓) Disconnect the frequency counter from the Deviation Meter.

Proceed to "Main Circuit Board Calibration."



Alignment Using FM Receiver

- () If you have purchased the optional Antenna Accessory for the Deviation Meter, connect the antenna to the RF INPUT jack of the Meter. If you do not have the Antenna Accessory, use the length of red test wire, and push the bare wire tip into the center of the RF INPUT jack.
- () Place the Deviation Meter close to your FM receiver. Turn the receiver on.

IMPORTANT: In the following steps, to accurately align the local oscillator in the Deviation Meter, you must know the frequency of the stations heard on your FM receiver; for example, one popular midwest station is at 98.7 MHz, and another is at 106.7 MHz.

To adjust the **low** end of the band, you must select a station whose frequency, **when divided by 3 or by 4**, will fall between 25 and 30. Similarly, to adjust the high end of the band, you should use a station whose frequency, **when divided by 2**, will fall between 45 and 50. For example, if a station can be found whose frequency is at 99.9 MHz it will meet both of these requirements (use 100 MHz for easier calculations). In your own area, you may have to select two separate stations.

Refer to Pictorial 6-1 for the following steps.

NOTE: You will be instructed to adjust coil L202 and trimmer C211 in the following steps. Use the coil alignment tool and adjust L202 through the converter shield hole marked "LO." Adjust trimmer C211 with the trimmer alignment tool through the shield hole marked "HI."

Adjust coil L202 and trimmer C211 as follows:

- () Push the Deviation Meter ON-OFF switch to ON.
- () 1. Select a weak FM station on your receiver whose frequency, **when divided by 3 or by 4**, falls between 25 and 30. Set the Deviation Meter pointer to that number.
- () 2. Adjust coil L202 (LO) carefully in either direction as you listen to the receiver speakers for a cancellation of the sound. Do not adjust L202 further at this time. **NOTE:** If you do not get sound cancellation as described, use a weaker station or disconnect the antenna.

- () 3. If necessary, return your FM receiver to a station whose frequency, **when divided by 2**, falls between 45 and 50. Set your Deviation Meter to that number.
- () 4. Adjust trimmer C211 (HI) in either direction as you listen for a cancellation of sound from the speakers. Do not adjust the trimmer further at this time.

NOTE: If you cannot adjust capacitor C211 to at least 49.9 MHz at the high frequency end, refer to "High Frequency Adjustment" following this section.

- () 5. Repeat Steps 1 through 4 until no further improvement can be made.
- () Push the ON-OFF switch to OFF.
- () Remove the wire or antenna from the Meter.

Proceed to "Main Circuit Board Calibration."

High Frequency Adjustment

Refer to the inset drawing on Pictorial 6-1 (Illustration Booklet, Page 9) for the following steps.

- () 1. Temporarily remove the converter shield cover.
- () 2. With the trimmer alignment tool, turn capacitor C211 to minimum — with the moveable metal rotor down as shown.
- () 3. Adjust **coil L202** for the high frequency indication; that is, a cancellation of the sound from the speakers or a frequency meter reading of 50 MHz.
- () 4. Following the directions for a low-frequency reading, slightly compress the **outer plates** of tuning capacitor C212 until the correct speaker cancellation or frequency meter indication is obtained.
- () 5. Repeat Steps 1 through 4 until both the high and low frequencies are aligned to within 0.1 MHz.
- () 6. Replace and secure the converter shield cover.



- () 7. Return to "Alignment Using Frequency Counter" or to "Alignment Using FM Receiver," and recheck all of the alignment steps under those headings; you should need to make only slight adjustments to either coil L202 or trimmer C211.

Proceed to "Main Circuit Board Calibration."

MAIN CIRCUIT BOARD CALIBRATION

Refer to Pictorials 5-2 and 6-2 (Illustration Booklet, Page 9) as you perform the following calibration steps.

- (✓) On the front panel of the Meter, set all the pushbutton switches to their "out" positions (press lightly on adjacent buttons).
- (✓) On the main circuit board, make sure the green jumper wire is connected to the 15V circuit board; all other jumper wires should be on their adjacent NORM circuit board pins.
- (✓) Push the ON-OFF switch to ON.
- (✓) Push in the 2 kHz DEVIATION switch.
- (✓) With the trimmer alignment tool, turn OFFSET control R171 clockwise as you watch the meter.

When the pointer swings upscale, stop. **Carefully** turn the OFFSET control counterclockwise until the meter pointer **just** stops at "0." NOTE: You may wish to repeat this step a few times to be sure.

- (✓) Push the ON-OFF switch to OFF.
- (✓) Move the red jumper wire to the CAL pin.
- () Move the orange jumper wire to the TUNE pin.
- (✓) Push the ON-OFF switch to ON.
- (✓) Push the TUNE switch in.
- (✓) Refer to Detail 6-2A and, using the coil alignment tool, adjust coil L101 as follows:
 - A. Turn the coil slug counterclockwise until it is at the top of the coil.
 - B. Turn the slug clockwise and watch the meter until you see the pointer rise rather abruptly to a mid-scale or higher reading. This is shown in the Detail as slope "A." Stop at the peak reading.

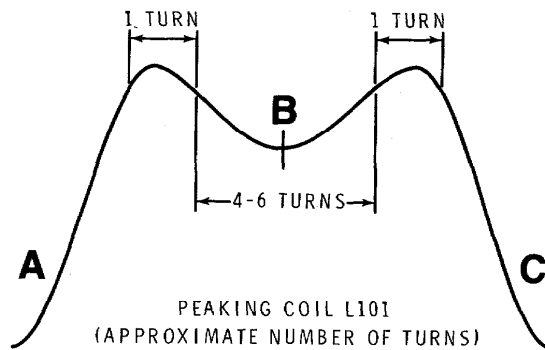

Detail 6-2A

- C. Continue turning the slug four to six more turns as you watch the meter indication dip and then slowly rise to a second peak. Count the turns from the first to the second peak. Stop.

NOTE: If you were to go clockwise beyond the second peak, the meter indication would resemble slope "C."

- D. Turn the slug counterclockwise from the second peak 1/2 the number of turns between the two peaks. Stop at the mid-point dip at "B."

- (✓) Push the ON-OFF switch to OFF.
- (✓) Connect the yellow jumper wire to CAL.
- (✓) Push the 75 kHz DEVIATION switch in.
- (✓) Push the ON-OFF switch to ON.
- (✓) Using the trimmer alignment tool, turn CAL control R138 and, as you watch the meter, set the control for a top-scale reading of exactly 20 on the 0-20 scale. NOTE: Repeat this operation as necessary to just get the pointer to the right scale index.
- (✓) Push the ON-OFF switch to OFF.
- (✓) On the main circuit board, return the yellow, orange, and red jumper wires to their adjacent NORM pins.
- (✓) Connect the violet wire to the adjacent NULL connector pin.

This completes the "Alignment and Calibration" of your FM Deviation Meter. Proceed to "Final Assembly."

FINAL ASSEMBLY

Refer to Pictorial 7-1 for the following steps.

- (✓) Position the back panel on a soft cloth as shown.
- (✓) From the paper insulator, cut a piece $3\text{-}1/4" \times 3\text{-}1/4"$.
- (✓) Remove the paper backing from the square paper insulator and press the paper in place on the inside of the rear panel as shown in the Pictorial. Be sure to position the paper between the two holes. Discard the remaining piece of insulator.

NOTE: If you are going to use batteries to power your Deviation Meter, make one final check at this time to make sure they are all correctly installed in the battery case.

- (✓) Secure the battery case and battery bracket to the rear panel with two sets of $6\text{-}32 \times 3/8"$ black phillips head hardware as shown. NOTE: Be sure to position the battery terminals toward the top edge of the panel.
- (✓) Position the rear of the main circuit board close to the inside of the rear panel as shown in the Pictorial; then connect the battery clip to the battery case terminals.

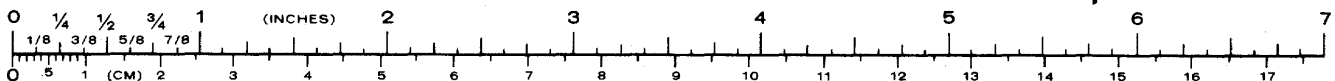
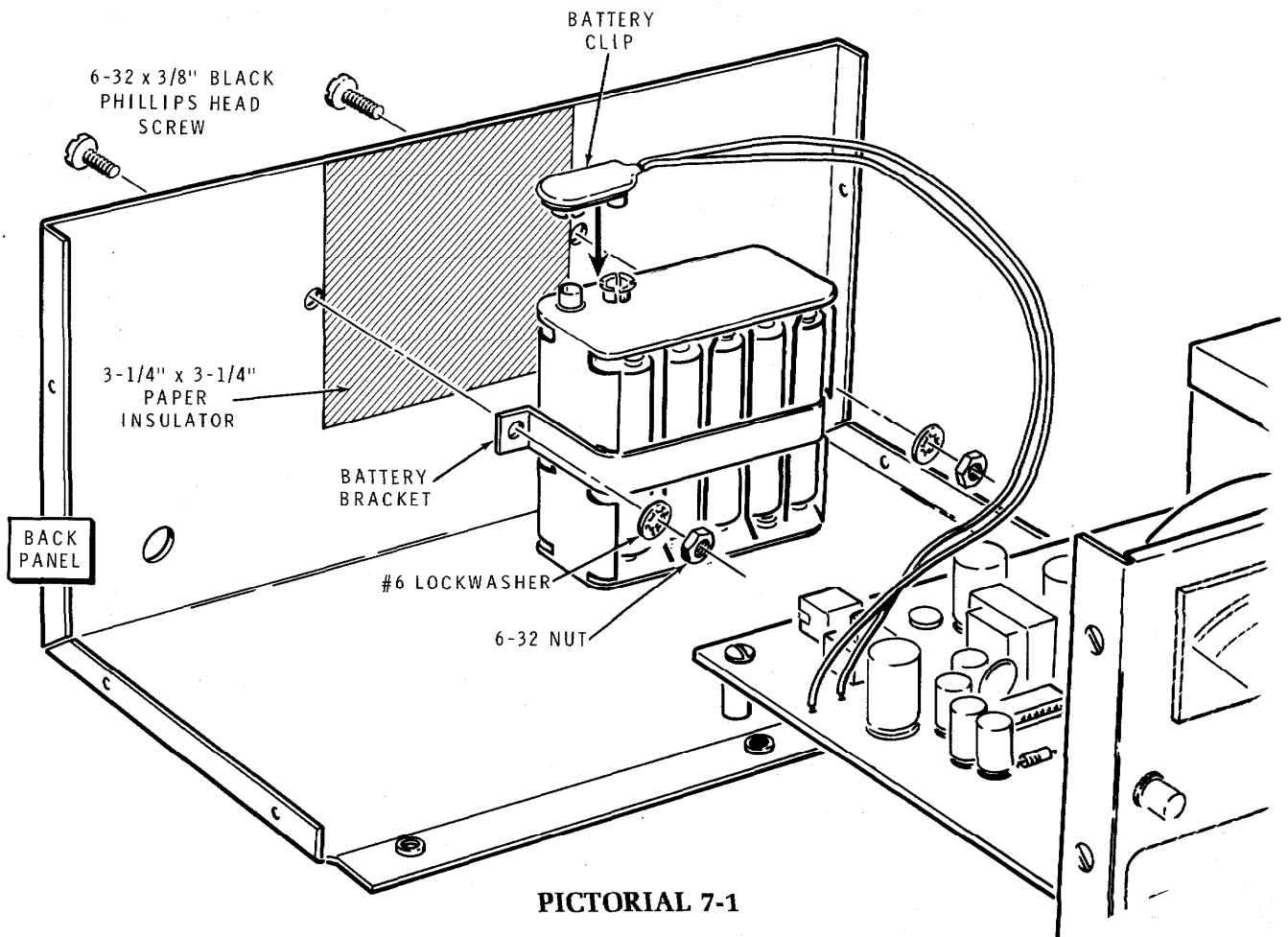

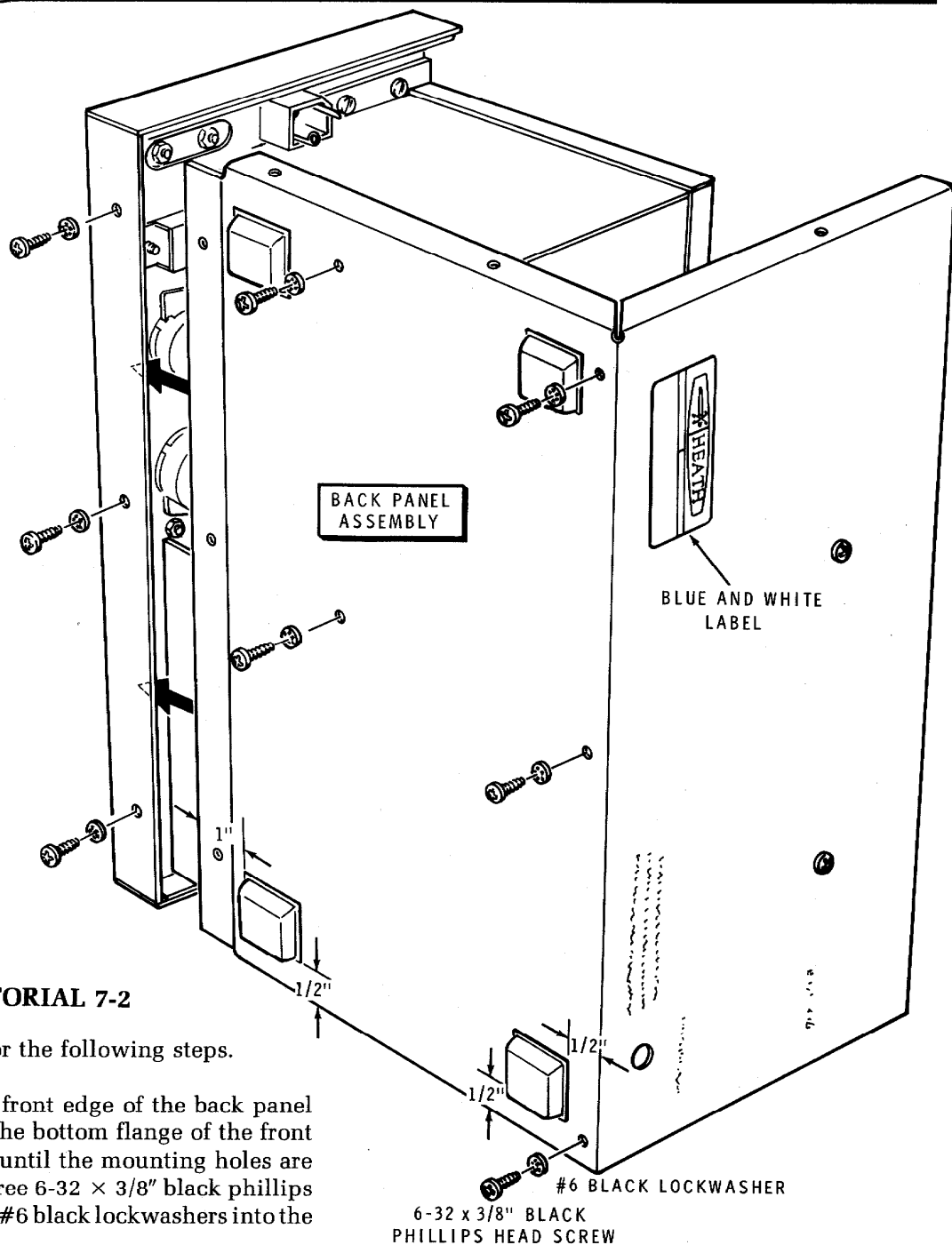

PICTORIAL 7-2

Refer to Pictorial 7-2 for the following steps.

- (✓) Slide the bottom front edge of the back panel assembly inside the bottom flange of the front panel. Push it in until the mounting holes are lined up. Start three 6-32 × 3/8" black phillips head screws with #6 black lockwashers into the mounting holes.
- (✓) Start five more 6-32 × 3/8" black phillips head screws with #6 black lockwashers through the bottom panel and into the circuit board spacers.
- (✓) After all the bottom panel mounting screws have been started, tighten all of them securely.
- (✓) Remove the paper backing from the blue and white label and press the label in place on the rear panel as shown. NOTE: Be sure to refer to

the numbers on this label in any communications you have with the Heath Company about this kit.

- (✓) Remove the paper backing from the four feet and press one foot onto each corner of the bottom of the Meter as shown in the Pictorial.
- (✓) Turn the Deviation Meter upright.

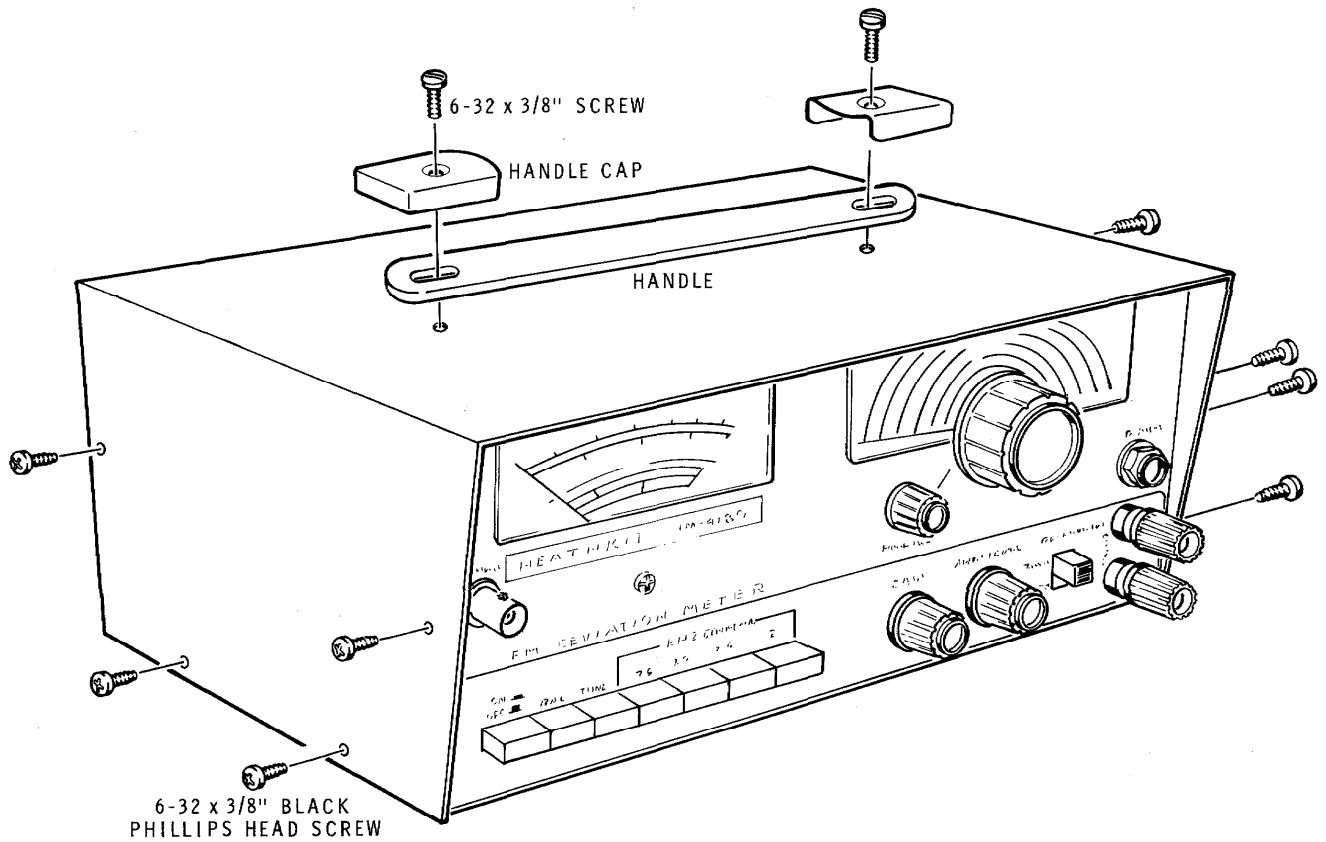

PICTORIAL 7-3

Refer to Pictorial 7-3 for the following steps.

- (✓) Mount the handle clips to the cabinet top with two 6-32 x 3/8" screws as shown.

NOTE: Before you secure the cabinet top, be sure that switch SW102 is correctly set to "CHARGE" if you are using rechargeable batteries.

- () Position the cabinet top down over the Deviation Meter assembly as shown. Then secure the cabinet top with eight 6-32 x 3/8" black phillips head screws.

This completes the "Step-by-Step Assembly" of your FM Deviation Meter.



OPERATION

Refer to Pictorial 8-1 (Illustration Booklet, Page 10) as you read the following information which is provided mainly to acquaint you with the controls, the switches, and the functions of the FM Deviation Meter. Further operational information is supplied under the heading "Applications." NOTE: The letters in front of each component called out in the following text, correspond to the lettering on Pictorial 8-1.

PUSHBUTTON SWITCH ASSEMBLY (SW101)

- A. ON-OFF switch (red): Use this switch to turn the power to the instrument on and off. If you use rechargeable batteries, the charge rate will not be affected by the position of this switch. Switch positions — In = ON, Out = OFF.
- B. BATT switch (white): Use this switch only for an internal check of the batteries. When batteries are used with the Deviation Meter, you should push this switch in occasionally to make sure the batteries are in good condition. Check the battery condition on the lowest scale of the meter; the pointer must be within the white portion labeled "BATT." If it is not, replace or recharge the batteries.
- C. TUNE switch (white): Use this switch in conjunction with the large tuning dial to seek the FM carrier signal you desire, which you will then tune to a peak indication on the meter using the controls as described in F. and G.
- D. Four kHz DEVIATION switches (2 red, 2 black): These switches indicate the maximum range of the deviation from the FM carrier signal — or full-scale deviation sensitivity. The two red pushbuttons at 75 and 7.5 kHz correspond to the red meter scale (0 - 7.5), while the two black pushbuttons corresponding to the black meter scale (0-20).

DE-EMPHASIS SWITCH (E.)

The DE-EMPHASIS switch selects 750 μ s de-emphasis as used in two-way radio systems, or 75 μ s de-emphasis as used in standard FM broadcasts. This switch affects only the speaker (SPKR) output. The measured deviation and scope outputs are unaffected by this switch.

CONTROLS

- F. MAIN TUNING (large knob): Controls the local oscillator main tuning function. Controls the action of tuning capacitor C212 through a 6:1 reduction drive and the positioning of the frequency dial pointer.
- G. FINE TUNE control (small knob): This control is primarily useful in the upper VHF and the UHF frequencies to assist in obtaining the best tuning indication. The MAIN TUNING is on frequency when the FINE TUNE knob index is aligned with the diagonal line on the front panel.
- H. GAIN control: Use this control to attenuate especially strong signals to keep the meter pointer within the "TUNE" range shown on the meter dial. Signals can be anywhere within the meter range without affecting the measured deviation.
- J. AUDIO LEVEL control: Controls the audio level at the SPKR output jack only. The control, when turned fully counterclockwise, switches off the power to the audio amplifier circuit to conserve battery energy.

INPUT/OUTPUT CONNECTIONS

- K. (INSET). Jack J101 (on rear panel—see the inset drawing on Pictorial 8-1): Plug the Battery Charger/Eliminator Accessory Model IMA-4180-1 into this jack to charge the optional nickel-cadmium batteries, or to power the Deviation Meter without batteries. If you use the batteries with this accessory power pack, they will be kept charged at all times; merely remove the Charger/Eliminator plug for battery-powered operation.
- L. SPKR Jack: A standard two-pole phone jack can be used to connect an 8-ohm speaker or headphones to the Deviation Meter. Monaural FM signals are amplified, detected, and coupled to the speaker output in a similar manner as in a standard receiver.



- M. **RF INPUT jack:** The jack is a standard BNC jack for use with shielded cables. Minimum sensitivity in the lower VHF bands is approximately 10 millivolts (see "Specifications," Page 55).
- N. **SCOPE jacks:** Demodulated audio signals can be coupled from the two scope jacks (signal + ground) to the input of an oscilloscope. This output is in the order of 13mV/kHz and is superimposed on a DC voltage which is proportional to the intermediate frequency.

STEP-BY-STEP OPERATING PROCEDURE

1. Push the ON-OFF switch to ON.
2. Check the batteries. Push the BATT switch in and be sure the batteries indicate good in the "BATT" area of the meter.
3. Connect an FM RF signal source to the RF INPUT front panel jack.
4. Set the FINE TUNE control index on the front panel diagonal line.
5. Turn the GAIN control fully clockwise.
6. Press the TUNE button in.
7. Turn the MAIN TUNING knob to the desired RF carrier frequency. **NOTE:** The Deviation Meter local oscillator frequency is at 0.2 MHz above and below the incoming carrier frequencies. If the meter pegs at the high end, turn the GAIN control to bring the pointer within the "TUNE" area on the meter dial. Retune, if necessary for a maximum meter indication. In tuning to the carrier frequency, two peaks will be observed. To tune for a positive deviation reading, select the lower-frequency peak reading. To tune for a negative deviation reading, tune to the higher peak. These peaks will occur at 0.2 MHz above and below the carrier frequency.

When you operate the Deviation Meter at higher frequencies, if you cannot obtain the minimum tune level indication, proceed as follows:

- a. Set the Meter to the desired frequency.
- b. Read the fundamental frequency on the 25-50 MHz scale.

- c. Add or subtract this number to or from the desired frequency.
- d. Retune to the resultant frequency.

Example: Desired frequency = 500 MHz.

Fundamental frequency (from 25-50 scale) = 31.2 MHz.

Added frequency: $500 + 31.2 = 531.2$ MHz.

Subtracted frequency: $500 - 31.2 = 468.8$ MHz.

NOTE: Make sure the Deviation Meter is not tuned to a harmonic frequency from the unit under test; incorrect deviation measurements could result.

8. In high VHF and the UHF bands, the positive and negative peaks will appear to be very close together. Use the FINE TUNE control, preset at midrange with the knob index, to obtain the desired peak. The FINE TUNE control works in same rotational direction as the MAIN TUNING control. **NOTE:** If the modulation signal is deviating more than 5 kHz, the modulation should be removed as you tune the instrument to avoid the possibility of tuning to a sideband. If the modulation is 5 kHz or less, the tuning will not be affected.
9. Press the appropriate kHz DEVIATION range pushbutton and read the amount of deviation from the meter. **NOTE:** The 2 kHz range circuit contains a 1.5 kHz low-pass filter to assist in the elimination of high-frequency noise at the lower modulation frequencies.
10. If desired, you may connect an 8-ohm speaker or a headset to the SPKR output jack on the front panel. Use a single-pole phone plug. Push the de-emphasis switch to the correct setting: 75 μ s for standard broadcast applications, 750 μ s for two-way radio applications.
11. If desired, connect an oscilloscope to the SCOPE output banana jack on the front panel.

NOTE: If you are going to use your Deviation Meter for continuous monitoring operation, you should occasionally recheck the tuning to be sure it is peaked on frequency.

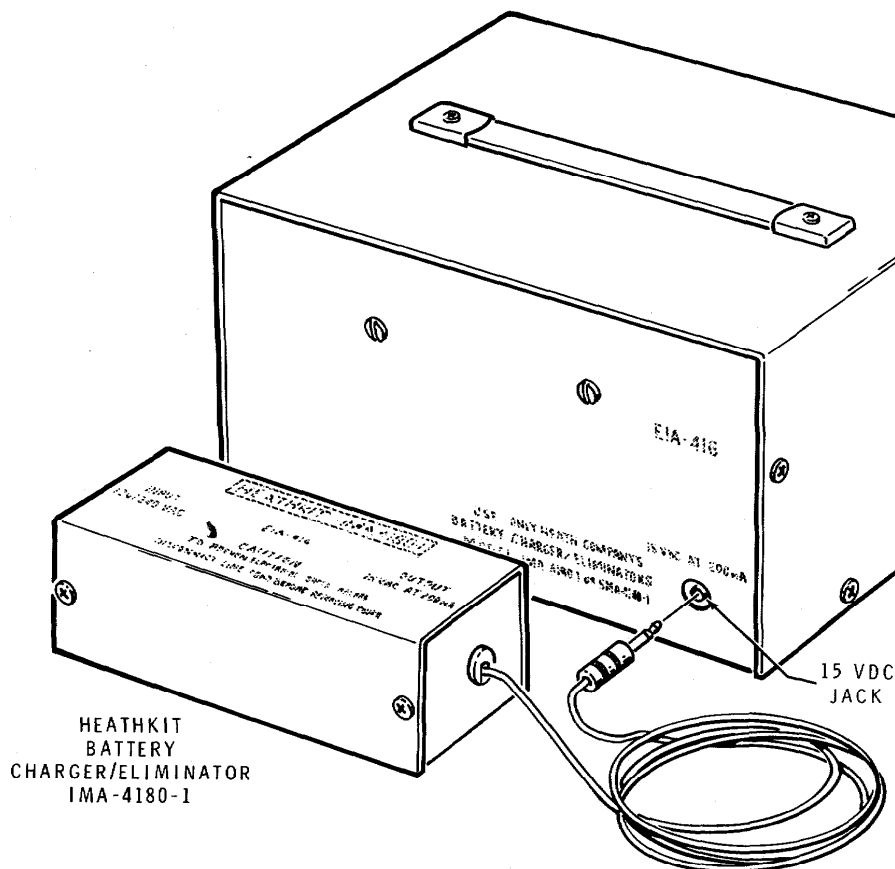

PICTORIAL 8-2

BATTERY CARE AND CHARGING

Refer to Pictorial 8-2 as you read the following information.

As explained in earlier sections of the Manual, only rechargeable nickel-cadmium (Nicad) batteries may be recharged. If you do not have rechargeable batteries in your Deviation Meter, you may omit reading this section. If you do have them, and do not keep your Battery Charger/Eliminator Accessory connected to the Deviation Meter at all times, you should frequently check the condition of your battery pack. When the meter reading indicates that the battery energy is low, just plug the Battery Charger/Eliminator Accessory into the Deviation shallow discharges, and by minimizing overcharges and heat.

Meter rear panel 15 VDC jack, plug the Charger into an AC outlet, and charge the batteries for several hours. To check the condition or state of charge on the batteries alone, the Charger must be temporarily disconnected from the Meter. Nickel-cadmium (NICAD) batteries are sealed, and contain no free electrolyte.

Therefore, you can store them either charged or discharged. They require no maintenance other than charging.

At room temperature, NICAD's will retain about 50% of their charge for three months. However, a few charge and discharge cycles will restore their full capacity. To increase their charge time, store the batteries at low temperatures. High temperatures decrease their life.

The useful life of a NICAD is from 300 to 1000 charge and discharge cycles. You can extend its life with shallow discharges, and by minimizing overcharges and heat.

An apparent early failure of a cell can occur when it is repeatedly subjected to shallow discharge and charge cycles. This is known as the "memory" or "hysteresis" effect and can be remedied by a few deep reconditioning cycles. To recondition a cell, discharge it to 1.0 volts at a rate of 360 mA. Then recharge it at a rate of 360 mA for 14 to 16 hours.

When a cell is discharged to less than 1.0 volt, the

remaining cells in the series string will begin charging it in the reverse direction. If this condition occurs, and you attempt to recharge the series string, the reversed cell can be permanently damaged. The reversed cell can usually be saved if you first short it to remove all its charge, then recharge it in the normal manner. However, repeated cell reversal will increase the internal cell pressure and cause the cell to vent and expell electrolyte. This is a permanent failure and the cell must be replaced.

APPLICATIONS

The input signal may be coupled to the Deviation Meter by a direct BNC shielded cable connector from signal generators and other low-power sources. For medium power sources, an attenuator should be used in the signal line. If relatively high-power sources are to be tested, a small antenna such as the Heathkit Model SU-510 can be used. High-level sources may slightly affect the local oscillator, but will not affect the deviation measurement. At higher UHF frequencies, high level signals will add some noise to the deviation measurement and will affect its accuracy. At these frequencies, you will attain the greatest accuracy with low-level signals. In some cases, high-power AM signals in your area can affect the operation of the Deviation Meter if you do not use shielded inputs. NOTE: If the deviation readings are several times greater than normal in a strong RF field, move your Meter a little further from the signal source.

Access tones used in two-way communications usually deviate several kilohertz and may be measured on the 7.5 kHz deviation range. Continuous tones such as those used in tone squelch circuits, deviate less and should be measured on the 2 kHz range. Since these tones are "sub-audible," a low pass filter is used in this lower range.

To describe the frequency response on the 2 kHz range, and if you wish to use that range with a modulating signal above 300 Hz, the effect of the low pass filter may be corrected by multiplying the deviation reading as follows:

$$\text{True Deviation} = D_0 \times \sqrt{1 + \left(\frac{F_m}{1500}\right)^2}$$

where D_0 = deviation reading, and F_m = modulating frequency.

The FM Deviation Meter has a bandpass similar to that found in a monaural FM broadcast receiver. If you are measuring stereo multiplex broadcasts, the

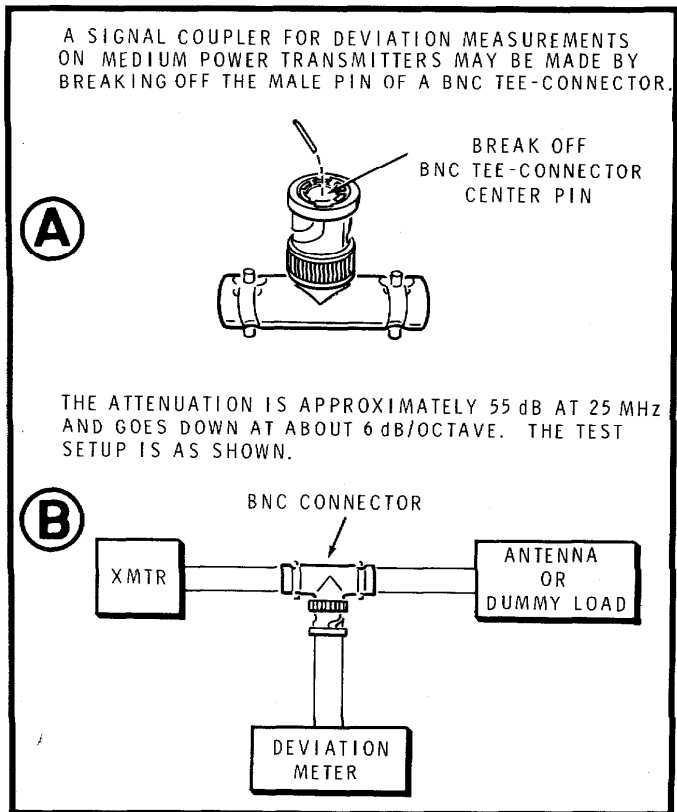

PICTORIAL 8-3

Meter will detect the deviation in the main (L + R) channel and will reject the deviation in the sub (L - R) channel. Thus, the instrument will "see" only half the modulation. For accurate deviation measurements, input signals should be from monaural sources; simply switch the stereo generator to the "MONO" mode of operation.

When you are measuring the deviation at high frequencies, care should be taken to be sure that the Deviation Meter is not subjected to shock or vibration; a slight disturbance of the local oscillator frequency will show up as a deviation reading.

In some cases, you may wish to connect the Deviation Meter directly into a transmission line to continuously monitor medium power transmitters. This can be done easily if you modify a BNC tee connector as shown in Part A of Pictorial 8-3. Be sure to remove the center pin of the connector to provide for proper signal attenuation before it appears at the RF INPUT of the Meter. The attenuation is thus approximately 55 dB at 25 MHz and drops approximately 6 dB per octave. Part B of Pictorial 8-3 shows a typical in-line, continuous monitoring setup for your FM Deviation Meter.



IN CASE OF DIFFICULTY

This part of the Manual will help you locate and correct any difficulty which might occur in your FM Deviation Meter. It is divided into two sections. The first section, "General," contains suggestions of a general nature in the following areas:

- A. Visual checks and inspections.
- B. Precautions to observe when bench testing.
- C. How to determine the area of the Meter in which the trouble is located.

The second section consists of a "Troubleshooting Chart." This chart calls out specific problems that may occur and lists one or more conditions or components that could cause each difficulty. The resistor R-numbers, capacitor C-numbers, diode D-numbers, and the transistor Q-numbers are identified in these charts by the same numbers that are used in the "Parts List," in the assembly steps, and on the Schematic Diagram. "Circuit Board X-Ray Views" (Illustration Booklet, Page 11) are also provided to help you locate the components and test points.

NOTE: In an extreme case where you are unable to resolve a difficulty, refer to the "Customer Service" information inside the rear cover of the Manual. Your Warranty is inside the front cover.

GENERAL

Visual Checks

1. Again make the visual checks at the end of each circuit board assembly section.
2. About 90 percent of the kits that are returned for repair do not function properly due to poor connections and soldering. Therefore, many troubles can be eliminated by a careful inspection of connections to make sure they are soldered properly. Reheat any doubtful connections and be sure all the wires are soldered at places where several wires are connected.
3. Check to be sure that all transistors and integrated circuits are in their proper locations, and are installed correctly.
4. Check the value of each part. Be sure the proper part has been wired into the circuit, as shown in the Pictorial diagrams and as called out in the wiring instructions. It would be easy, for example, to install a 2200 Ω (red-red-red) resistor in a step that calls for 220 Ω (red-red-brown) resistor.
5. Recheck the wiring. Trace each lead in colored pencil on the Pictorial as it is checked. It is frequently helpful to have a friend check your work. Someone who is not familiar with the unit may notice something you have consistently overlooked.
6. Check all component leads connected to the circuit boards. Make sure the leads do not extend through the circuit board and make contact with the other connections or parts, such as shields or the chassis.
7. Check all the wires and cables that are connected to the circuit boards. Make sure the wires do not touch the chassis or other lugs. Make sure all wires are properly soldered.
8. You may find it helpful if you read the "Circuit Description" on Page 57 as you refer to the fold-in Schematic Diagram.
9. If the difficulty still is not cured, read the "Precautions for Bench Testing" section and the section titled "How to Troubleshoot Your FM Deviation Meter."

Precautions for Bench Testing

1. Be cautious when you test transistor and IC circuits. Although these devices have a long life when used properly, they will be almost instantly destroyed when short circuited.
2. Be sure you do not short any terminals to ground when you make voltage measurements. If the probe slips, for example, and shorts out a bias or voltage supply point, it is almost certain to damage one or more transistors, IC's, or diodes.
3. Do not remove transistors or IC's while the Deviation Meter is turned on, since this would surely damage the instrument.
4. Do not remove circuit boards while the Deviation Meter is turned on.



How to Troubleshoot Your FM Deviation Meter

If you know which area your trouble is in, apply the "Visual Checks" to that area.

You may also go directly to the "Troubleshooting

Charts" to see if the difficulty you are having is listed in one of the "Condition" columns. If your difficulty is listed there, check the "Possible Cause" column listed for that item and apply the visual check to the area of difficulty.

Troubleshooting Chart

This "Troubleshooting Chart" lists specific difficulties that could occur in your Deviation Meter. Several possible causes may be listed for each difficulty.

Refer to the "Circuit Board X-Ray Views" (Illustration Booklet, Page 11) to locate and identify parts.

	CONDITION	POSSIBLE CAUSE
1.	Deviation Meter does not operate.	<ol style="list-style-type: none"> 1. Battery clip loose. 2. Dead batteries. 3. Charger/Eliminator not connected.
2.	8-volt regulator will not adjust.	<ol style="list-style-type: none"> 1. Control R186. 2. Integrated circuit U108. 3. Capacitors C101 or C154.
3.	Deviation readings too high or too low.	<ol style="list-style-type: none"> 1. Recalibrate instrument (See "Main Circuit Board Calibration," Page 45.)
4.	Batteries test out of "Battery" area on meter.	<ol style="list-style-type: none"> 1. Recharge batteries. 2. Replace lead-acid or alkaline batteries.
5.	Batteries will not charge using Battery Charger/Eliminator.	<ol style="list-style-type: none"> 1. Charge switch SW102 not in CHARGE position. 2. Diode D108.
6.	No deviation reading (SPKR and SCOPE outputs OK).	<ol style="list-style-type: none"> 1. Diode D107. 2. Meter. 3. Capacitor C143. 4. Integrated circuit U106.
7.	No SCOPE output (deviation reading OK).	<ol style="list-style-type: none"> 1. Resistor R154. 2. Coil L102. 3. Capacitor C133.
8.	Tune function works but will not peak.	<ol style="list-style-type: none"> 1. Coil L101.
9.	No deviation or SPKR output (tune function and battery test OK).	<ol style="list-style-type: none"> 1. Diodes D101, D102, D103, D105, and D202. 2. Transistors Q101, Q102, Q103, or Q202. 3. Integrated circuits U101 through U105.
10.	Unit lacks sensitivity.	<ol style="list-style-type: none"> 1. Control R1. 2. Diode D202. 3. Transistors Q101, Q201, or Q202.
11.	FINE TUNE control inoperative.	<ol style="list-style-type: none"> 1. Control R3. 2. Capacitor C154. 3. Diode D201.



CONDITION	POSSIBLE CAUSE
12. No SPKR output — or weak or distorted (deviation OK).	1. Control R4/switch SW2. 2. Switch SW1. 3. Capacitors C1, C145, C146, C147, or C148. 4. Transformer T101. 5. Integrated circuit U107.
13. No SPKR output (in only one position of DE-EMPHASIS switch).	1. Switch SW1. 2. Resistors R152 or R153.
14. No meter indication during "Main Circuit Board Calibration."	1. Adjust coil L101. 2. Filter Y101. 3. Or — (See items listed under Condition 9).
15. Will not calibrate to full scale.	1. Recheck 8V ADJ control R186. 2. Integrated circuits U103-U106.

SPECIFICATIONS

Carrier Frequency Ranges

On fundamental of local oscillator 25 — 50 MHz.

On harmonics of local oscillator 50 — 1000 MHz.

Deviation Ranges 0-2, 0-7.5, 0-20, and 0-75 kHz peak.

Accuracy (full scale) $\pm 3\%$.

Sensitivity (Gain control fully cw)

25-50 MHz 10 mV minimum.

50-500 MHz 35 mV minimum.

500-1000 MHz 100 mV minimum.

Residual FM and Noise (35 mV input level at 500 MHz)

On 7.5, 20, and 75 kHz ranges 250 Hz maximum.

On 2 kHz range 100 Hz maximum.



Input Impedance (nominal)	50 ohms.
Maximum Safe Input	5 volts.
Scope Output (nominal)	13 mV/kHz peak.
Speaker Output (5 kHz deviation, 400 Hz modulation, 750 μ s de-emphasis)	100 mW minimum, into 8-ohm speaker.
De-emphasis	
Two-way radio	750 μ s.
Broadcast	75 μ s.
Modulation Frequency Response	
— At 7.5, 20, 75 kHz:	
50 Hz—9 kHz	± 0.5 dB.
10 Hz—13 kHz	— 3dB.
— At 2.0 kHz:	
50—500 Hz	± 0.5 dB.
Local Oscillator Drift	± 10 kHz at 50 MHz, first hr. after turn-on.
Operating Temperature Ranges	
Within rated accuracy	20° — 30°C.
Eight percent accuracy	0 — 50°C.
Power Supply	Ten AA cells, NEDA type 15, zinc-carbon, alkaline, or nickel-cadmium.
Optional power source	Battery Charger/Eliminator Accessory, Model IMA-4180-1.
Battery Life:	
Zinc-carbon or alkaline intermittent use w/o speaker	Approx. 80 hrs.
Nickel-cadmium (Nicad)	35 hrs. per charge.
Dimensions (overall)	5" high \times 10-5/16" wide \times 7-3/16" deep (12.7 \times 26.2 \times 18.3 cm).
Net weight	4-1/4 lbs (1.9 kg).

The Heath Company reserves the right to discontinue products and to change specifications at any time without incurring any obligations to incorporate new features in products previously sold.



CIRCUIT DESCRIPTION

A number series has been assigned to the circuit components mounted on the chassis and on the circuit boards. These numbers are referred to throughout the sections of the Manual to help you locate and identify the components. These components are grouped as follows:

- 1-99 Parts mounted on the chassis.
- 101-199 Parts mounted on the main circuit board.
- 201-299 Parts mounted on the converter circuit board.

Refer to the Block Diagram (Illustration Booklet, Page 10) and to the fold-in Schematic Diagram as you read this "Circuit Description."

GENERAL

RF signals from a signal generator or a transmitter are coupled to the RF Input jack on the FM Deviation Meter by shielded cable, a wire, or through an accessory antenna. The RF signals are routed into the converter assembly where they are mixed with a local oscillator signal, the frequency of which is .2 MHz above or below the incoming signal. The two signals are mixed with the output of a harmonic generator and are coupled through a preamplifier and an IF amplifier.

The amplified IF signal is then coupled through a limiter and a waveshaper circuit in which the signal is formed into a square wave to drive a trigger circuit. The trigger output feeds into a monostable multivibrator whose duty cycle varies according to the deviation frequency. The output of the multivibrator passes through two stages of low-pass filters to produce a demodulated audio signal. The audio signal is then routed in two directions. In one direction, the signal goes through a switch attenuator network, a peak detector, and is coupled to the output meter. Routed in the other direction, the audio signal is passed through a de-emphasis network, across a level control, and into an audio amplifier. The output of the audio amplifier is coupled directly to a speaker (or head-phone) jack on the front panel.

Power is supplied to the Meter circuits from ten NEDA Type 15 (AA) batteries or from a Battery Charger/Eliminator Accessory. Fifteen-volt power is taken directly from the power source. Eight-volt power for the integrated circuits is obtained from an integrated circuit regulator and a filter.

CONVERTER CIRCUITS

A dual-gate MOSFET, Q202, is a variable frequency oscillator. Coil L202B resonates with tuning capacitor C212 to determine the oscillator frequency. Coil L202B provides positive feedback to Q202 gate 1 (G1). Fine tuning is provided by control R3 and variable capacitance diode D201.

Transistor Q201 is a harmonic generator. The oscillator signal from the drain (D) of Q202 is DC coupled into the base (B) of Q201. Capacitor C201 in the emitter (E) circuit of Q201 stores a charge to keep the transistor turned off the greater part of each cycle. On negative excursions of the signal at the base of Q201, the collector conducts short, high-harmonic current pulses.

A hot-carrier diode, D202, is a frequency converting mixer. The current pulses from the collector of Q201 are coupled to the anode of D202 and the incoming RF signals are coupled to its cathode. The derived intermediate frequency (IF) signal is created in a low-pass filter consisting of coil L201, resistor R201, and capacitor C202.

IF CIRCUITS

IF signals are coupled from the output of the converter circuit to the (IF) Gain control. The attenuated IF signal is then routed into the base of preamplifier transistor Q101 on the main circuit board. Transistor Q101 is a low-noise preamplifier with a gain of 10. Its collector output is coupled through capacitor C104 and into pin 3 of operational IF amplifier integrated

circuit U101. U101 is a wide-band amplifier with a gain of 80. The IF signal, as it is coupled from output pin 6 of U101 to the input of U102, is routed across a limiter network consisting mainly of diodes D101 and D102. This limiter circuit removes the peaks from the IF signal and effectively creates square waves from it for most input signal levels.

The square-wave signal is routed into operational amplifier IC U102 pin 3 which functions as a waveshaper and squelch circuit. Positive feedback from C115 causes the output square wave from pin 6 to switch up and down very rapidly. An offset bias on the input from the limiter diodes provides a squelch action for low-level signals.

Transistor Q102 functions as a trigger circuit. Positive current spikes are coupled into the base of Q102 through capacitor C116. The collector output is positive-going trigger pulses; which are coupled to integrated circuit U103 through capacitor C118 and resistors R131 and R132. Operational amplifier IC U103 is a monostable multivibrator whose output is normally low. When a trigger pulse from Q102 is present on input pin 2, its output rises. Regeneration is provided by capacitor C121 to input pin 3 through resistor R136. The output pulse width at U103 pin 6 is set to approximately 1.6 μ s by Calibration (CAL) control R138.

Two operational amplifier IC's, U104 and U105, are low-pass filters. The inputs to the filters are pulses of fixed width and amplitude with spacing that varies according to the deviation frequency.

AUDIO CIRCUITS

The pulses are integrated and demodulated by the low-pass filter network and, at the output, are the FM audio signals. A resistive voltage divider consisting of resistors R156, R157, and R158, form a range divider. The demodulated signal coming from U105 pin 6 is a full-scale 7.5 kHz signal. At the junction of resistors R156 and R157, the signal is 20 kHz full-scale, and at the junction of R157 and R158, the signal is 75 kHz full-scale.

The 2 kHz range uses the same signal as the 7.5 kHz range, but the gain of the peak detector is changed by switching resistor R161 into the circuit, along with low-pass filter resistor R155 and capacitor C138.

Operational amplifier IC U106 is a peak detector whose input is a signal selected by the range switch attenuator circuit. The output of U106 is rectified by diode D107 and the signal is stored in capacitor C143. The direct current developed at the output of U106 flows through the meter and develops a negative feedback voltage across resistor R167. Resistor R161 shunts resistor R167 to reduce negative feedback on the 2 kHz range.

AUDIO OUTPUT

Resistors R152 and R153 with capacitor C1 form a de-emphasis circuit. Audio signals coming from IC U105 are routed into both resistors and through one of them, as determined by the setting of De-emphasis switch SW1, and on into capacitor C1 and Audio Level control R4.

Audio signals from the center tap of control R4 are routed to U107 pin 7. The amplified audio output signal is coupled from U107 pin 12 through capacitor C149 to the primary winding of audio transformer T101. Audio output signals are coupled from the secondary winding of T101 to the output Speaker jack J4 on the Deviation Meter front panel. Switch SW2 is ganged onto the shaft of Audio Level control R4. When control R4 is turned fully counterclockwise, SW2 turns off the power to the audio amplifier circuit to conserve battery energy.

POWER SUPPLY

Power for the FM Deviation Meter is taken from ten Type AA (NEDA Type 15) batteries and (or) an optional Battery Charger/Eliminator Accessory. Zinc-carbon or alkaline non-rechargeable cells with a useful life of approximately 80 hours may be used without the Charger/Eliminator pack, or rechargeable nickel-cadmium batteries may be used for a charged useful period of approximately 35 hours. These batteries are optional as the Deviation Meter can operate directly from the accessory power pack with no batteries at all. The 15-volt power source is taken directly from the battery or power pack through On-Off switch SW101A contacts. Power for the 8-volt supply also comes from this source.



Integrated circuit U108 functions as an adjustable voltage regulator. DC voltage from the power source is coupled into U108 pins 2 and 3. The regulated output at pin 1 is coupled through resistor R183 to provide overload current limiting. 8V Adj control R186 sets the 8-volt level for the IC and transistor circuits.

If the Battery Charger/Eliminator Accessory pack is used, resistor R181 limits current flow to the batteries. Switch SW102 is used in the Charge position when rechargeable batteries are used, and in the No Charge position for all other Charger and battery applications.

TUNED CIRCUIT AND RESONATOR

Coil L101 and capacitor C112 form a 200 kHz resonant circuit. IF amplifier IC U101 supplies the resonant circuit through resistor R116. The resultant resonant circuit voltage feeds detector diode D106. During calibration, resonator Y101 is coupled into a positive feedback path and causes the IF amplifier and preamplifier to oscillate at 200 kHz.

SEMICONDUCTOR CHARTS

DIODES

COMPONENT	HEATH PART NO.	MANUFACTURER'S NUMBER	IDENTIFICATION
D106	56-26	1N191	<div style="border: 1px solid black; padding: 5px;"> <p>IMPORTANT: THE BANDED END OF DIODES CAN BE MARKED IN A NUMBER OF WAYS.</p> <p style="text-align: center;">BANDED END</p> </div>
D108	57-65	1N4002	
D202	56-636	HP5082-2811	
D101-D105, D107	56-56	1N4149	
D201	56-642	MV2107	

TRANSISTORS

COMPONENT	HEATH PART NO.	MANUFACTURER'S NUMBER	IDENTIFICATION
Q102	417-91	2N5232A	<p style="text-align: center;">OR</p>
Q103	417-118	2N3393	
Q201	417-260	2N4258A	
Q101	417-283	SMO7275	

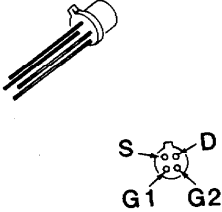

TRANSISTORS

COMPONENT	HEATH PART NO.	MANUFACTURER'S NUMBER	IDENTIFICATION
Q202	417-863	MFE131	

INTEGRATED CIRCUITS

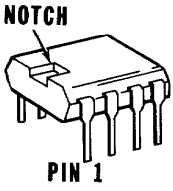
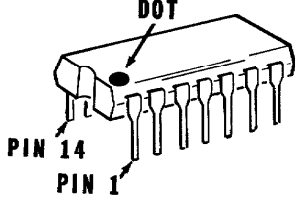
COMPONENT	HEATH PART NO.	MANUFACTURER'S NUMBER	IDENTIFICATION
U101-U106	442-623	CA3130S	
U108	442-24	LM376N	
U107	442-610	TBA820L	

WAVEFORMS

NOTE: Bold letters correspond to test points on the Schematic Diagram at which the waveforms are measured.

Deviation Meter setup procedure to obtain the waveforms is as follows:

Input Carrier Frequency: 25 MHz.

Deviation Frequency: 5 kHz.

Modulation Frequency: 1 kHz.

Signal tuned for Fundamental Frequency (25 MHz) on Deviation Meter with Gain Control set to produce a full-scale meter reading.

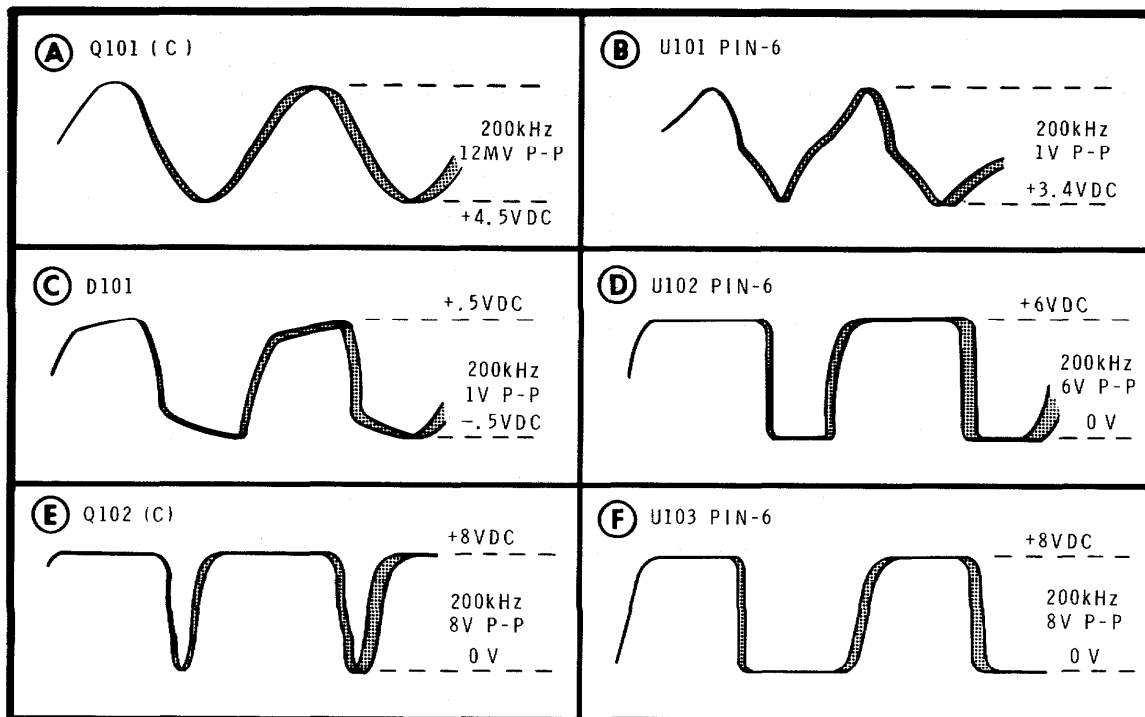

FOR PARTS REQUESTS ONLY

- Be sure to follow instructions carefully.
- Use a separate letter for all correspondence.
- Please allow 10 - 14 days for mail delivery time.

DO NOT WRITE IN THIS SPACE

INSTRUCTIONS

- Please print all information requested.
- Be sure you list the correct **HEATH** part number exactly as it appears in the parts list.
- If you wish to prepay your order, mail this card and your payment in an envelope. Be sure to include 10% (25¢ minimum, \$3.50 maximum) for insurance, shipping and handling. Michigan residents add 4% tax.
Total enclosed \$ _____
- If you prefer COD shipment, check the COD box and mail this card. COD

NAME _____
 ADDRESS _____
 CITY _____
 STATE _____ ZIP _____

The information requested in the next two lines is not required when purchasing nonwarranty replacement parts, but it can help us provide you with better products in the future.

Model # _____ Invoice # _____
 Date _____ Location _____
 Purchased _____ Purchased _____

LIST HEATH PART NUMBER	QTY.	PRICE EACH	TOTAL PRICE
TOTAL FOR PARTS			
HANDLING AND SHIPPING			
MICHIGAN RESIDENTS ADD 4% TAX			
TOTAL AMOUNT OF ORDER			

SEND TO: **HEATH COMPANY**
 BENTON HARBOR
 MICHIGAN 49022
ATTN: PARTS REPLACEMENT

Phone (Replacement parts only): 616 982-3571

THIS FORM IS FOR U.S. CUSTOMERS ONLY
 OVERSEAS CUSTOMERS SEE YOUR DISTRIBUTOR

FOR PARTS REQUESTS ONLY

- Be sure to follow instructions carefully.
- Use a separate letter for all correspondence.
- Please allow 10 - 14 days for mail delivery time.

DO NOT WRITE IN THIS SPACE

INSTRUCTIONS

- Please print all information requested.
- Be sure you list the correct **HEATH** part number exactly as it appears in the parts list.
- If you wish to prepay your order, mail this card and your payment in an envelope. Be sure to include 10% (25¢ minimum, \$3.50 maximum) for insurance, shipping and handling. Michigan residents add 4% tax.
Total enclosed \$ _____
- If you prefer COD shipment, check the COD box and mail this card. COD

NAME _____
 ADDRESS _____
 CITY _____
 STATE _____ ZIP _____

The information requested in the next two lines is not required when purchasing nonwarranty replacement parts, but it can help us provide you with better products in the future.

Model # _____ Invoice # _____
 Date _____ Location _____
 Purchased _____ Purchased _____

LIST HEATH PART NUMBER	QTY.	PRICE EACH	TOTAL PRICE
TOTAL FOR PARTS			
HANDLING AND SHIPPING			
MICHIGAN RESIDENTS ADD 4% TAX			
TOTAL AMOUNT OF ORDER			

SEND TO: **HEATH COMPANY**
 BENTON HARBOR
 MICHIGAN 49022
ATTN: PARTS REPLACEMENT

Phone (Replacement parts only): 616 982-3571

THIS FORM IS FOR U.S. CUSTOMERS ONLY
 OVERSEAS CUSTOMERS SEE YOUR DISTRIBUTOR

CUT ALONG DOTTED LINE

CUSTOMER SERVICE

REPLACEMENT PARTS

Please provide complete information when you request replacements from either the factory or Heath Electronic Centers. Be certain to include the **HEATH** part number exactly as it appears in the parts list.

ORDERING FROM THE FACTORY

Print all of the information requested on the parts order form furnished with this product and mail it to Heath. For telephone orders (parts only) dial 616 982-3571. If you are unable to locate an order form, write us a letter or card including:

- Heath part number.
- Model number.
- Date of purchase.
- Location purchased or invoice number.
- Nature of the defect.
- Your payment or authorization for COD shipment of parts not covered by warranty.

Mail letters to: Heath Company
Benton Harbor
MI 49022
Attn: Parts Replacement

Retain original parts until you receive replacements. Parts that should be returned to the factory will be listed on your packing slip.

OBTAINING REPLACEMENTS FROM HEATH ELECTRONIC CENTERS

For your convenience, "over the counter" replacement parts are available from the Heath Electronic Centers listed in your catalog. Be sure to bring in the original part and purchase invoice when you request a warranty replacement from a Heath Electronic Center.

TECHNICAL CONSULTATION

Need help with your kit? — Self-Service? — Construction? — Operation? — Call or write for assistance. you'll find our Technical Consultants eager to help with just about any technical problem except "customizing" for unique applications.

The effectiveness of our consultation service depends on the information you furnish. Be sure to tell us:

- The Model number and Series number from the blue and white label.
- The date of purchase.
- An exact description of the difficulty.
- Everything you have done in attempting to correct the problem.

Also include switch positions, connections to other units, operating procedures, voltage readings, and any other information you think might be helpful.

Please do not send parts for testing, unless this is specifically requested by our Consultants.

Hints: Telephone traffic is lightest at midweek — please be sure your Manual and notes are on hand when you call.

Heathkit Electronic Center facilities are also available for telephone or "walk-in" personal assistance.

REPAIR SERVICE

Service facilities are available, if they are needed, to repair your completed kit. (Kits that have been modified, soldered with paste flux or acid core solder, cannot be accepted for repair.)

If it is convenient, personally deliver your kit to a Heathkit Electronic Center. For warranty parts replacement, supply a copy of the invoice or sales slip.

If you prefer to ship your kit to the factory, attach a letter containing the following information directly to the unit:

- Your name and address.
- Date of purchase and invoice number.
- Copies of all correspondence relevant to the service of the kit.
- A brief description of the difficulty.
- Authorization to return your kit COD for the service and shipping charges. (This will reduce the possibility of delay.)

Check the equipment to see that all screws and parts are secured. (Do not include any wooden cabinets or color television picture tubes, as these are easily damaged in shipment. Do not include the kit Manual.) Place the equipment in a strong carton with at least **THREE INCHES** of *resilient* packing material (shredded paper, excelsior, etc.) on all sides. Use additional packing material where there are protrusions (control sticks, large knobs, etc.). If the unit weighs over 15 lbs., place this carton in another one with 3/4" of packing material between the two.

Seal the carton with reinforced gummed tape, tie it with a strong cord, and mark it "Fragile" on at least two sides. Remember, the carrier will not accept liability for shipping damage if the unit is insufficiently packed. Ship by prepaid express, United Parcel Service, or insured Parcel Post to:

Heath Company
Service Department
Benton Harbor, Michigan 49022

MAIN CIRCUIT BOARD

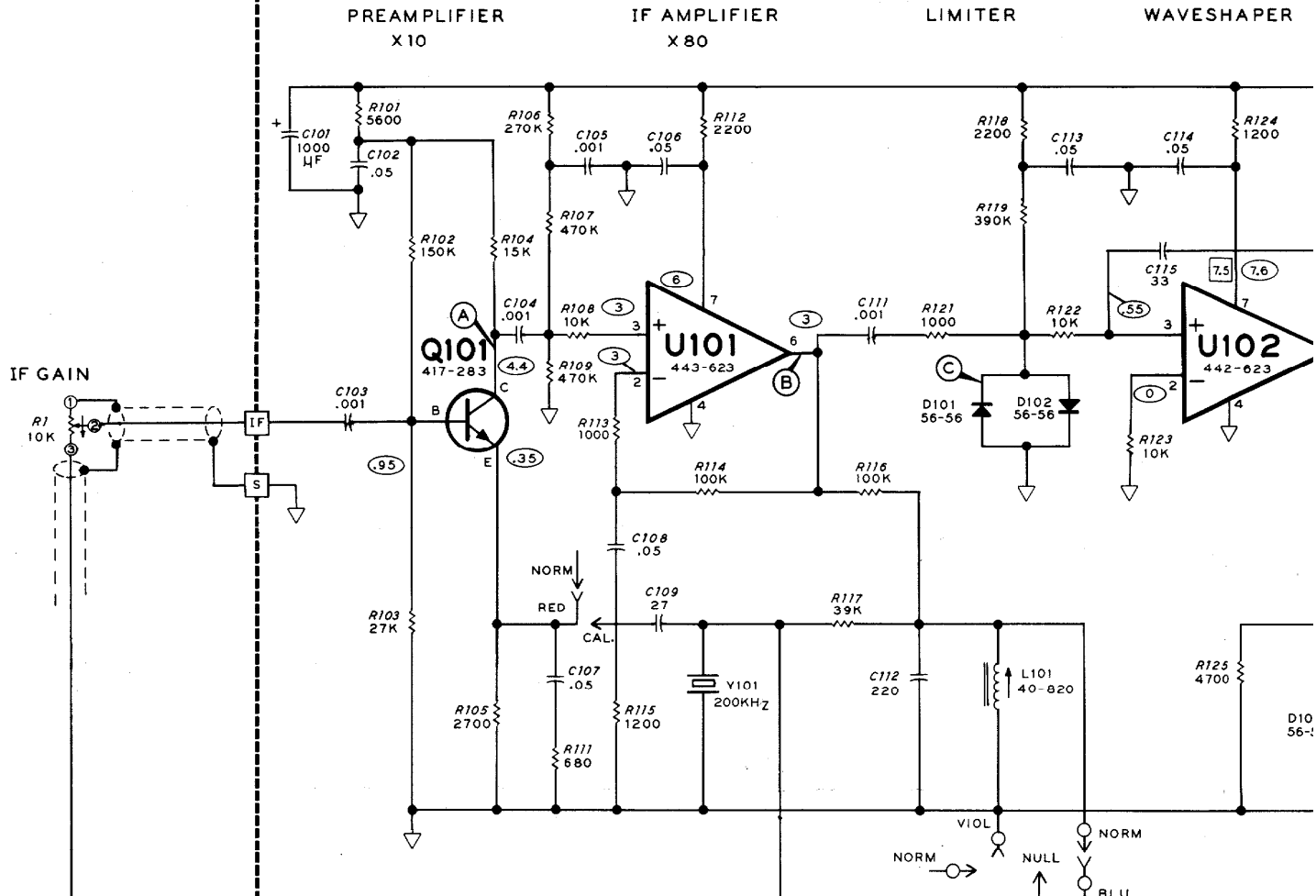

N CIRCUIT BOARD

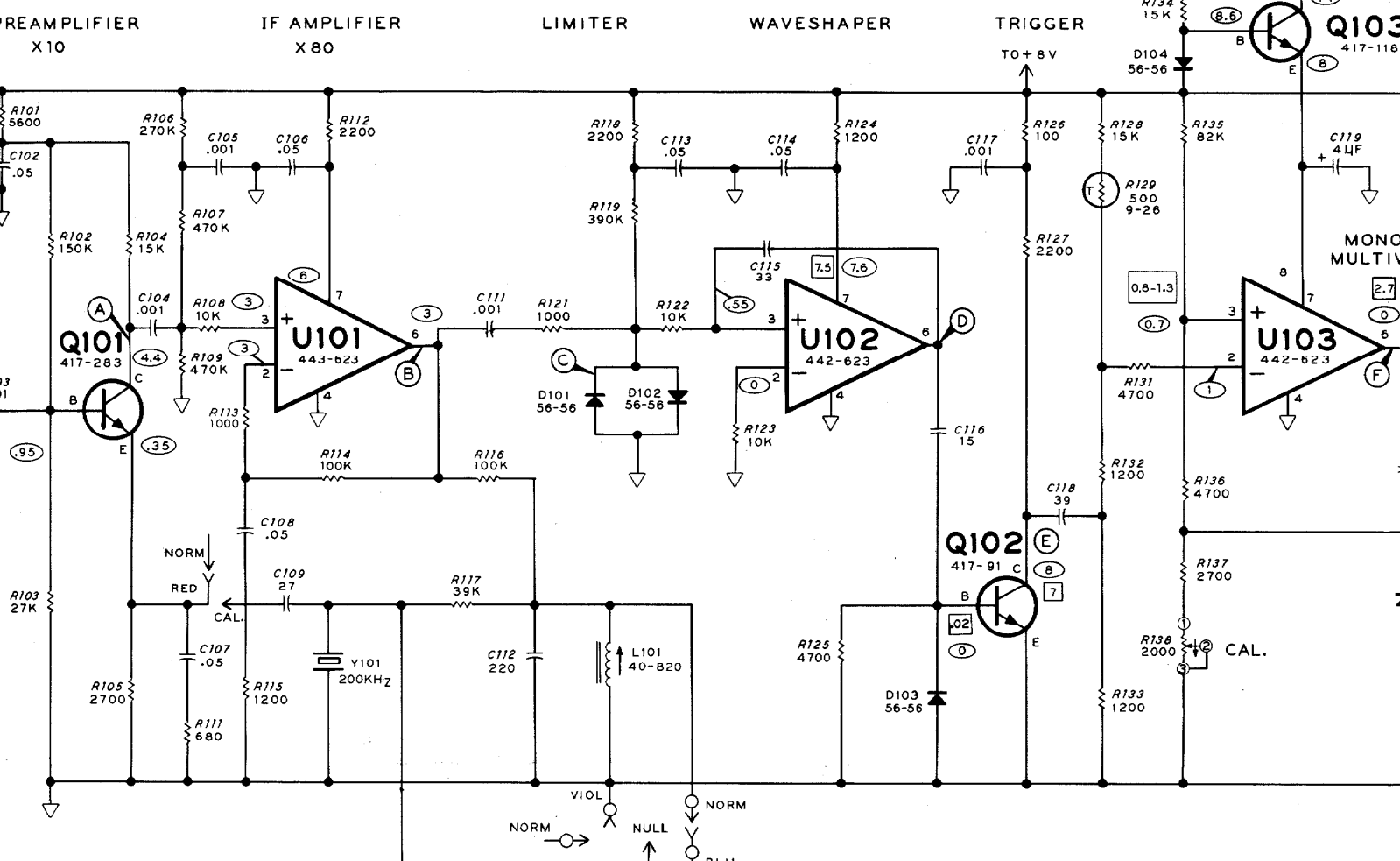

WAVE SHAPER

TRIGGER

LOW-PASS FILTERS

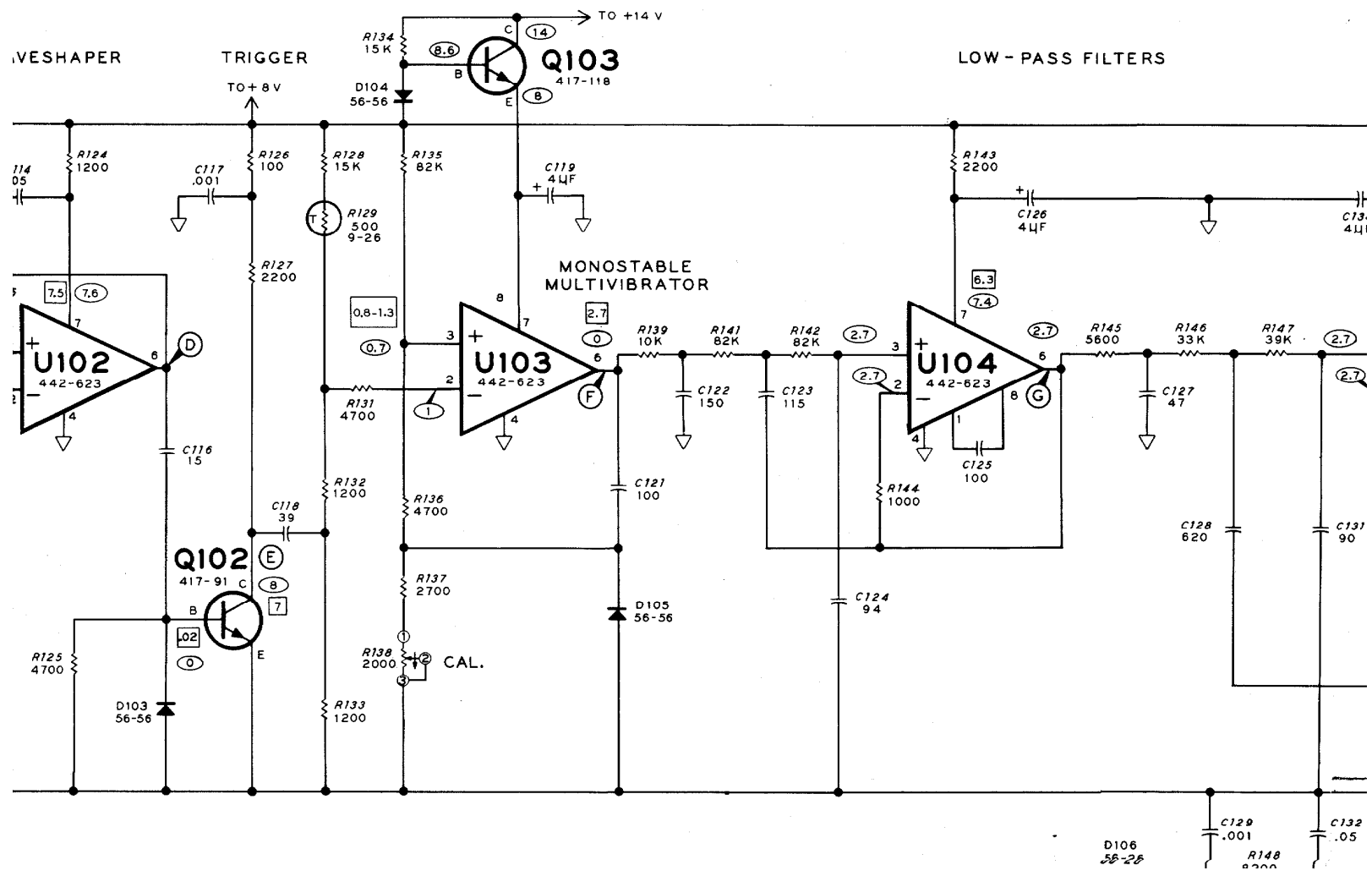

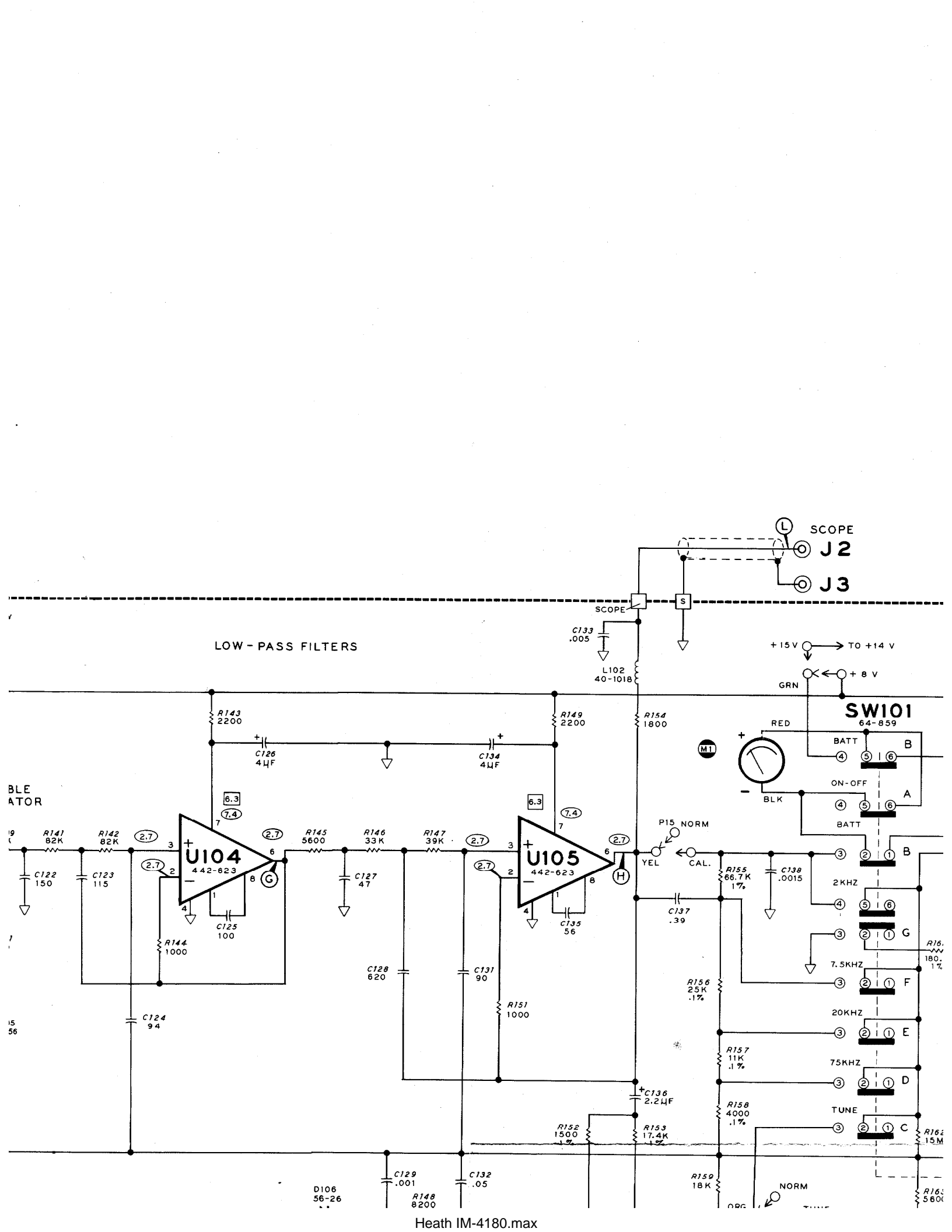

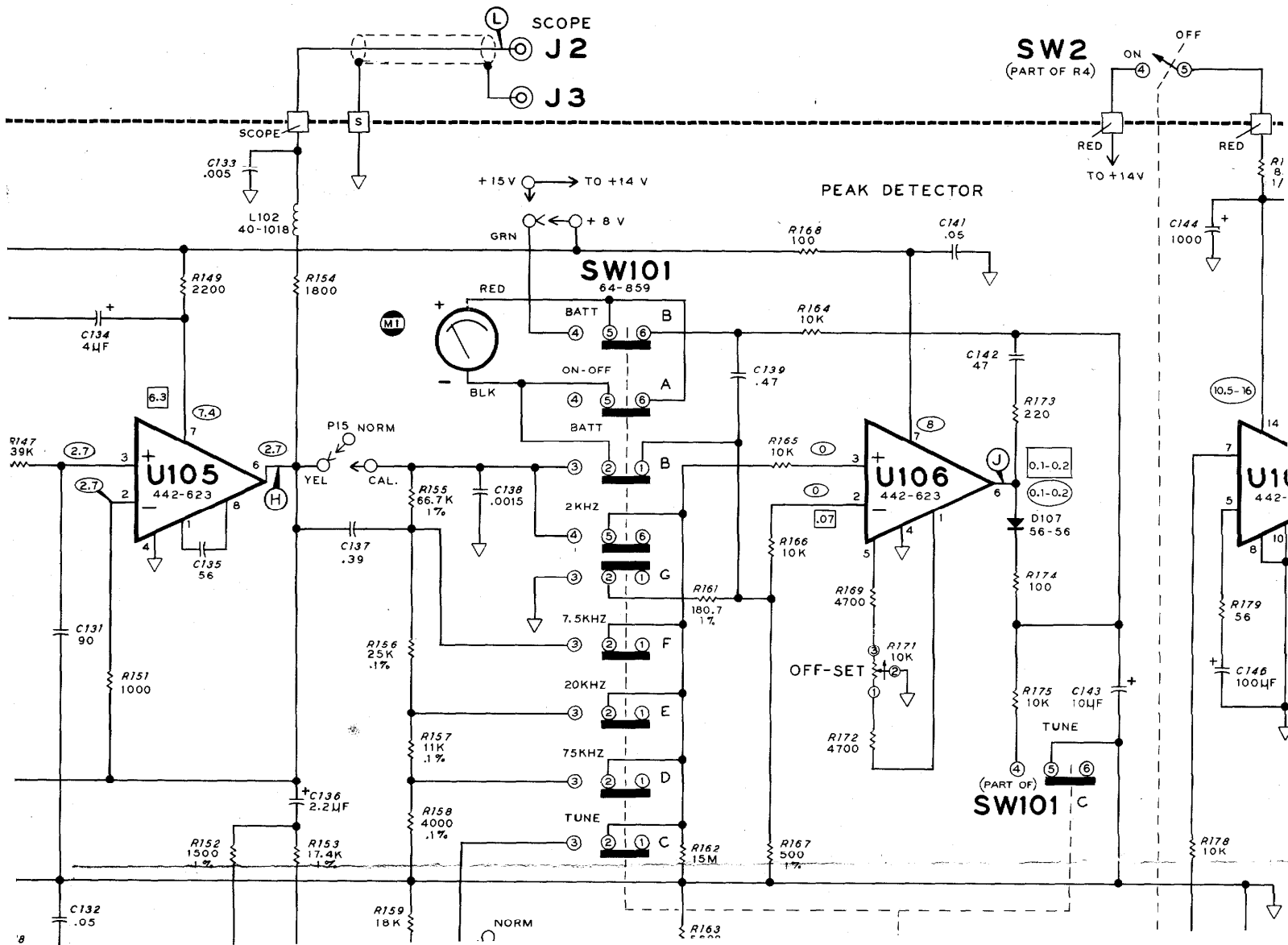

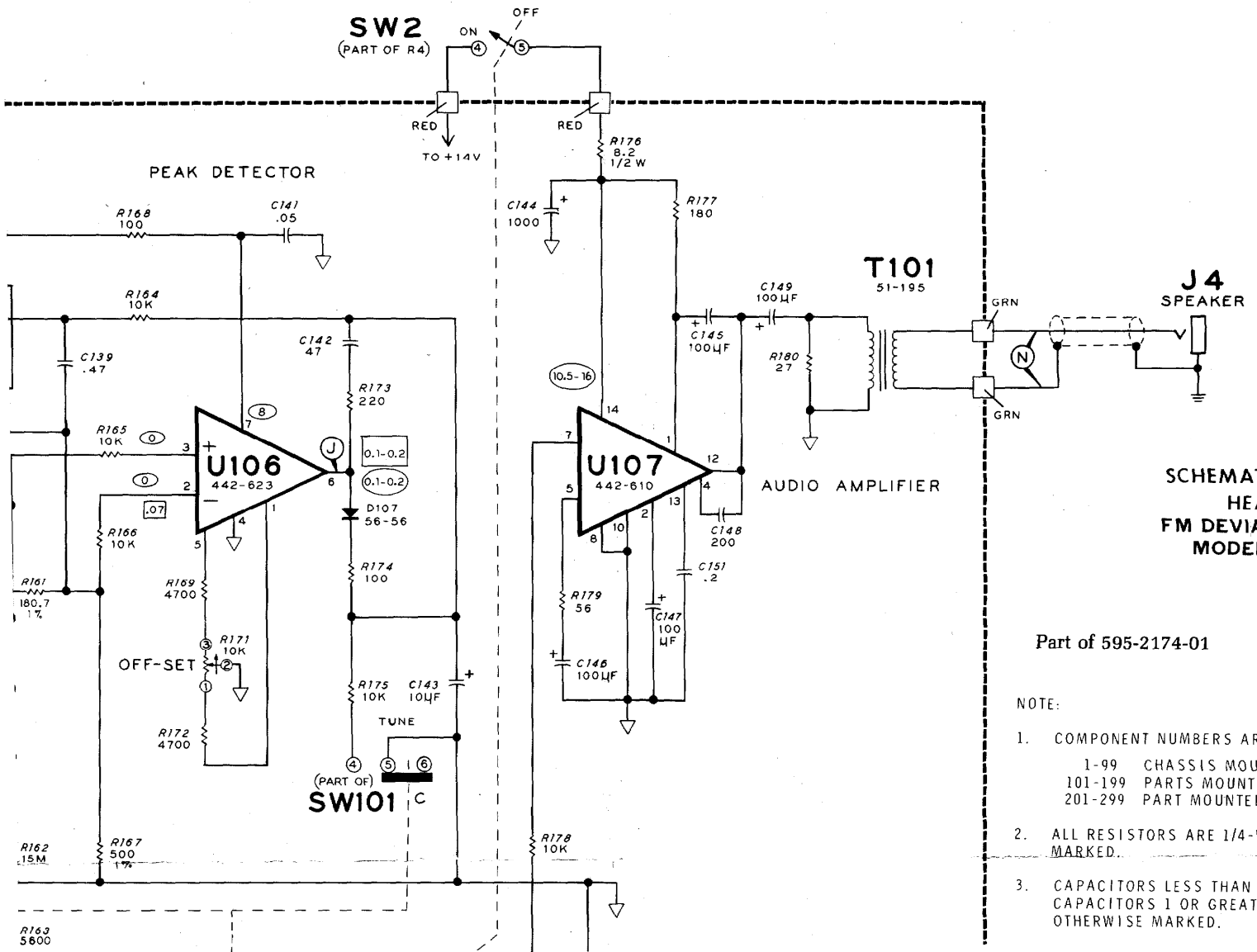

SCHEMATIC OF
HEATHKIT
FM DEVIATION
MODEL IM-4

Part of 595-2174-01

- NOTE:
1. COMPONENT NUMBERS ARE IN THE
1-99 CHASSIS MOUNTED PA
101-199 PARTS MOUNTED ON TR
201-299 PART MOUNTED ON THE
 2. ALL RESISTORS ARE 1/4-WATT, 5%
MARKED.
 3. CAPACITORS LESS THAN 1 ARE IN
CAPACITORS 1 OR GREATER ARE IN
OTHERWISE MARKED.

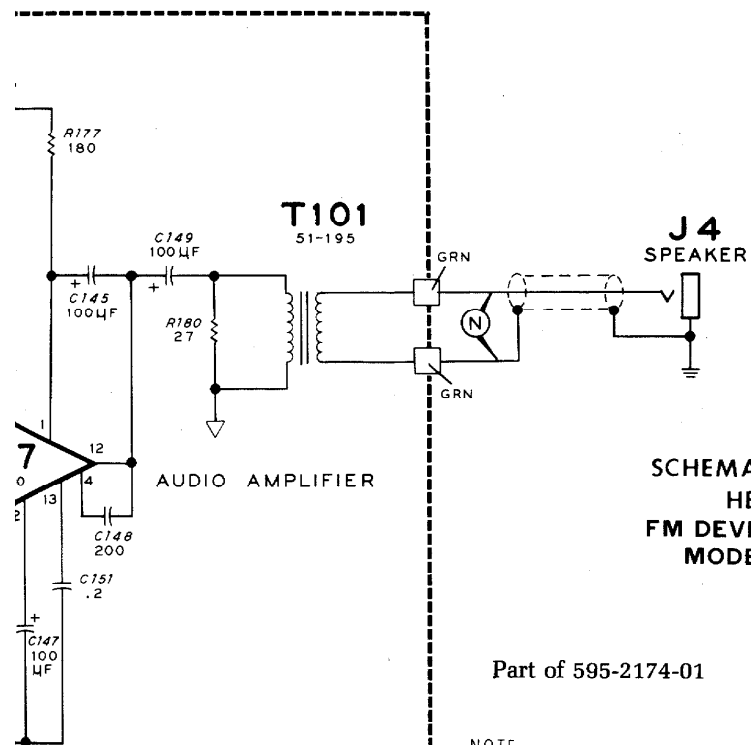

**SCHEMATIC OF THE
HEATHKIT®
FM DEVIATION METER
MODEL IM-4180**

Copyright © 1978
Heath Company
All Rights Reserved
Printed in the United States of America

Part of 595-2174-01

NOTE:

1. COMPONENT NUMBERS ARE IN THE FOLLOWING GROUPS:
 1-99 CHASSIS MOUNTED PARTS.
 101-199 PARTS MOUNTED ON THE MAIN CIRCUIT BOARD.
 201-299 PART MOUNTED ON THE CONVERTER CIRCUIT BOARD.
2. ALL RESISTORS ARE 1/4-WATT, 5% TOLERANCE UNLESS OTHERWISE MARKED.
3. CAPACITORS LESS THAN 1 ARE IN µF (MICROFARADS).
 CAPACITORS 1 OR GREATER ARE IN pF (PICOFARADS) UNLESS OTHERWISE MARKED.
4. THE FOLLOWING SYMBOLS ARE USED ON THIS SCHEMATIC DIAGRAM

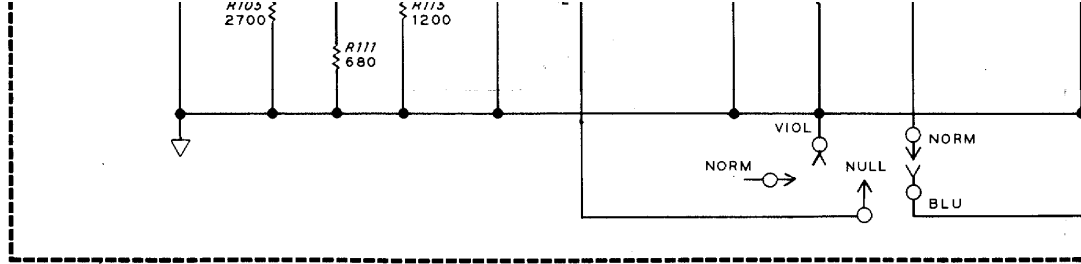

CONVERTER CIRCUIT BOARD

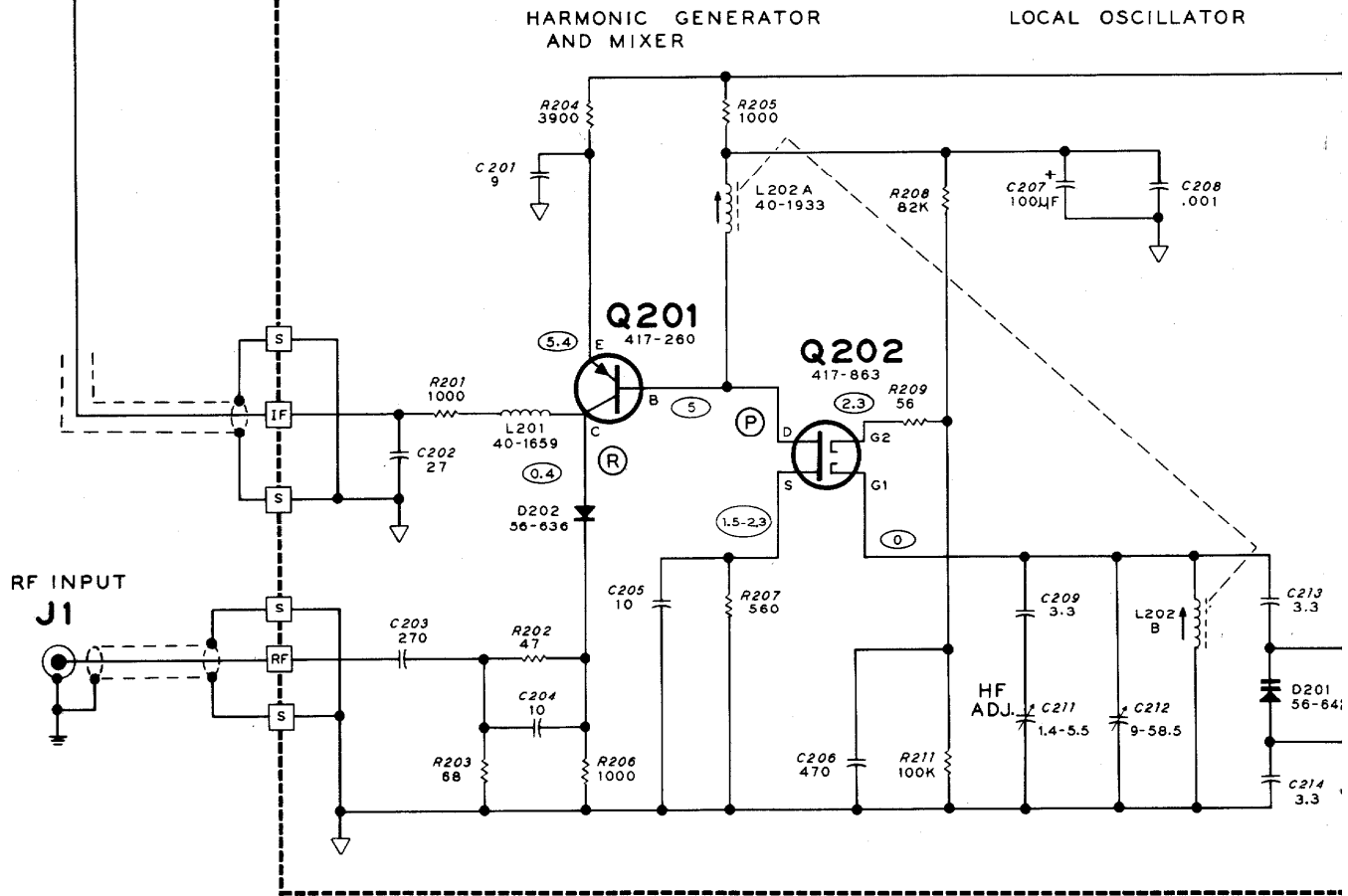

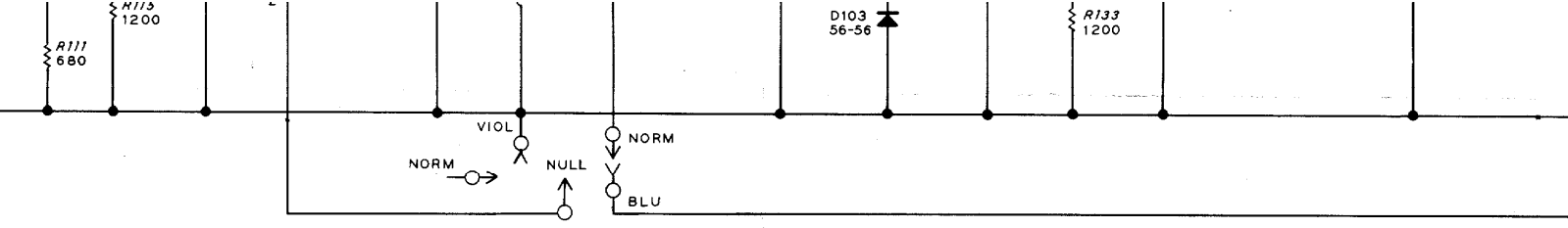

CIRCUIT BOARD

HARMONIC GENERATOR AND MIXER

LOCAL OSCILLATOR

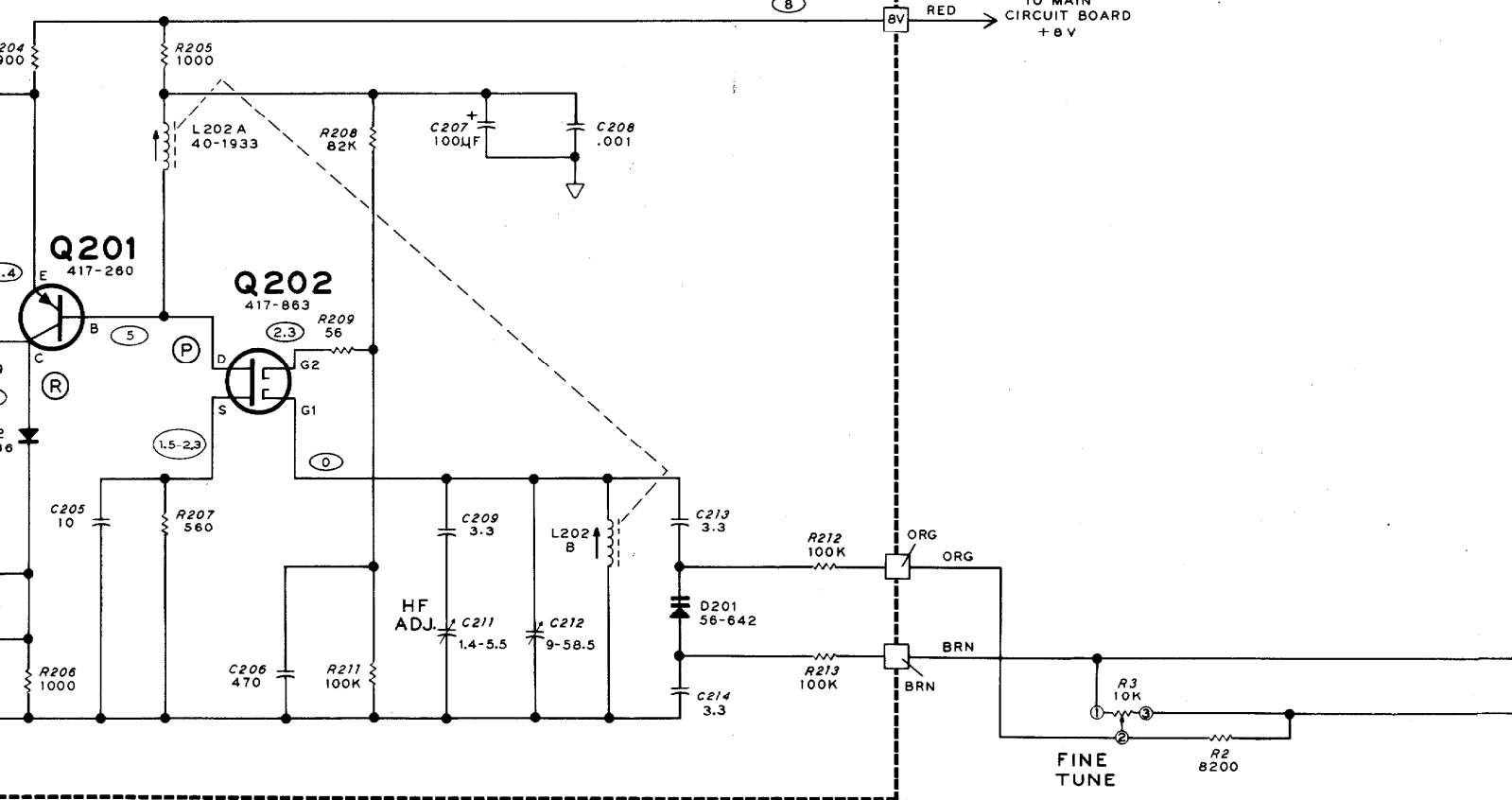

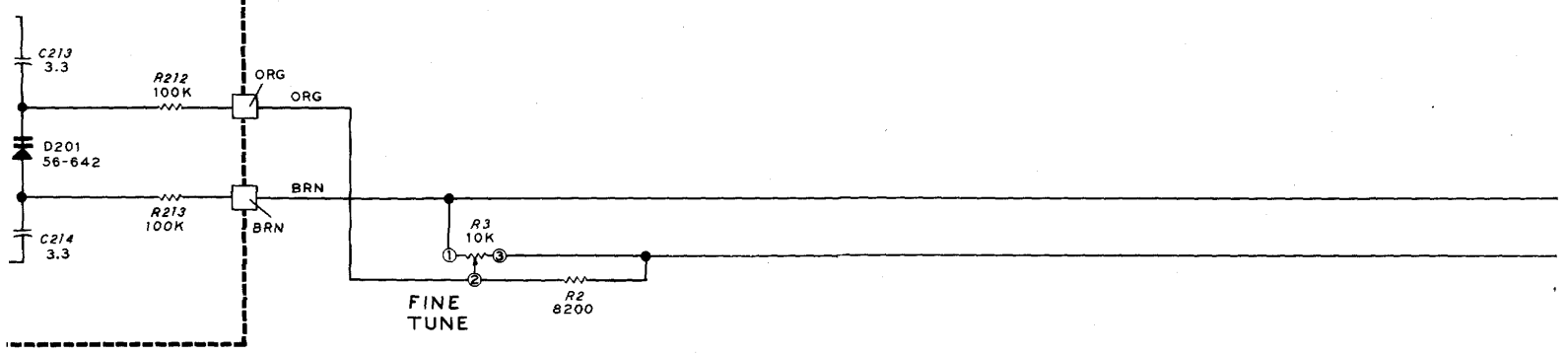
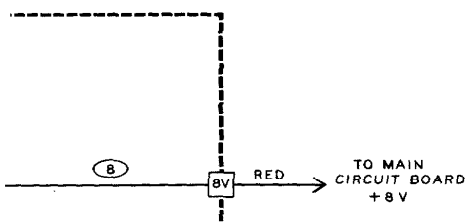
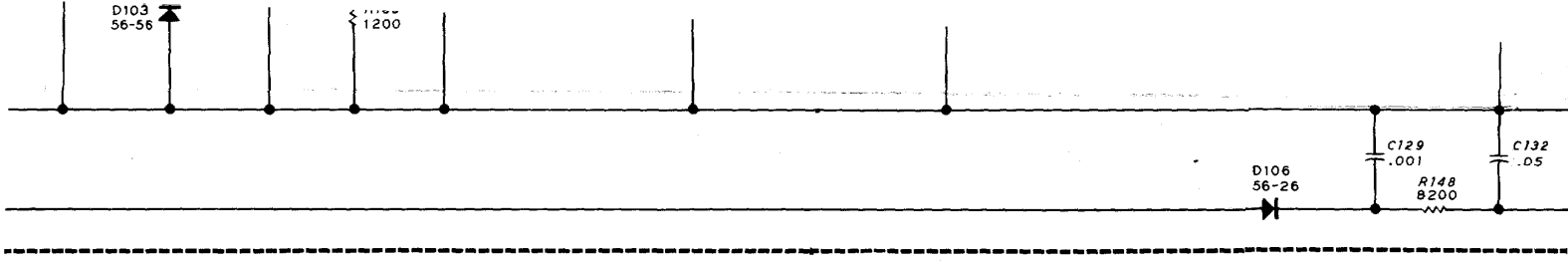

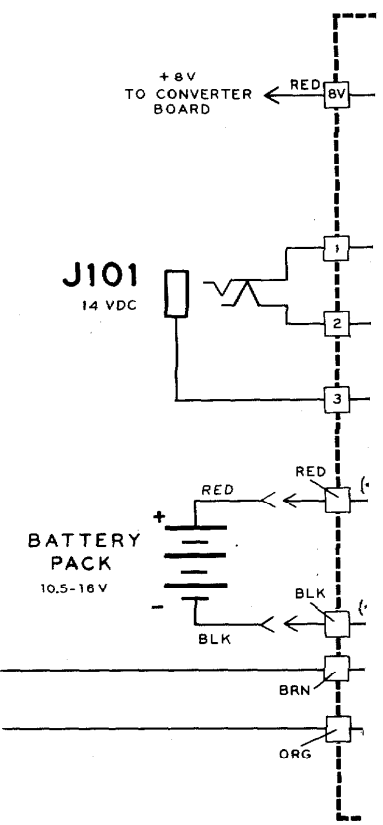
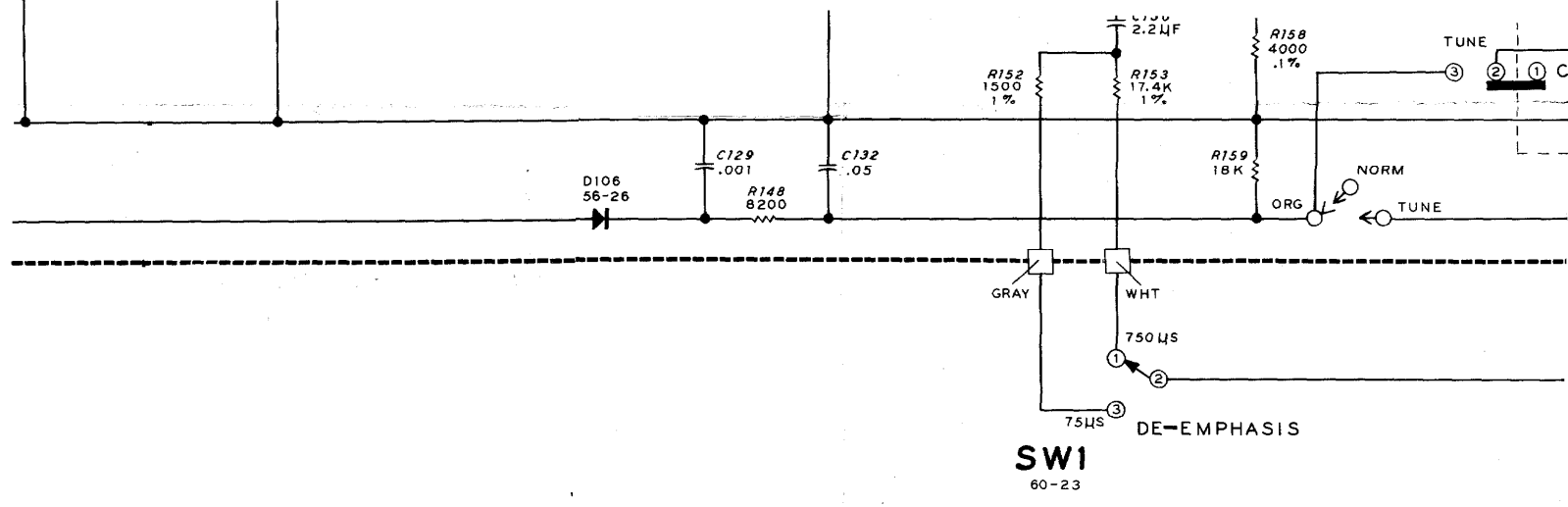

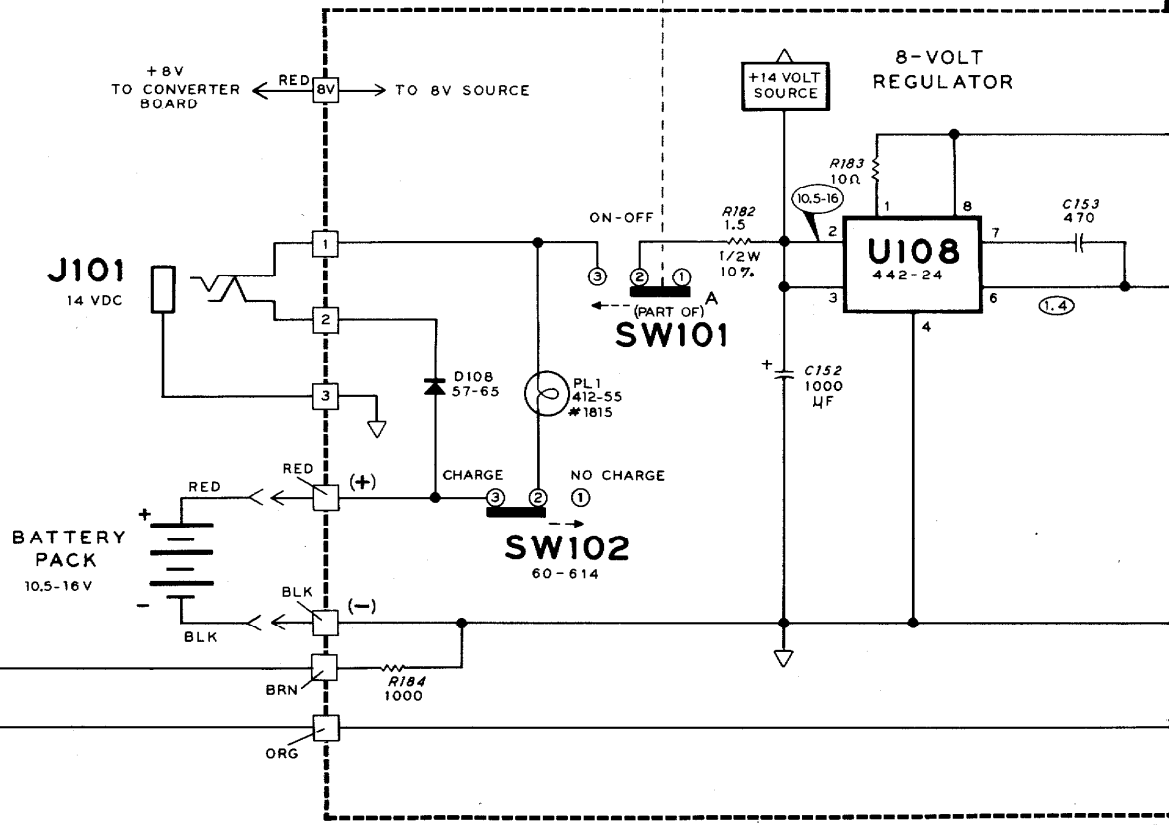
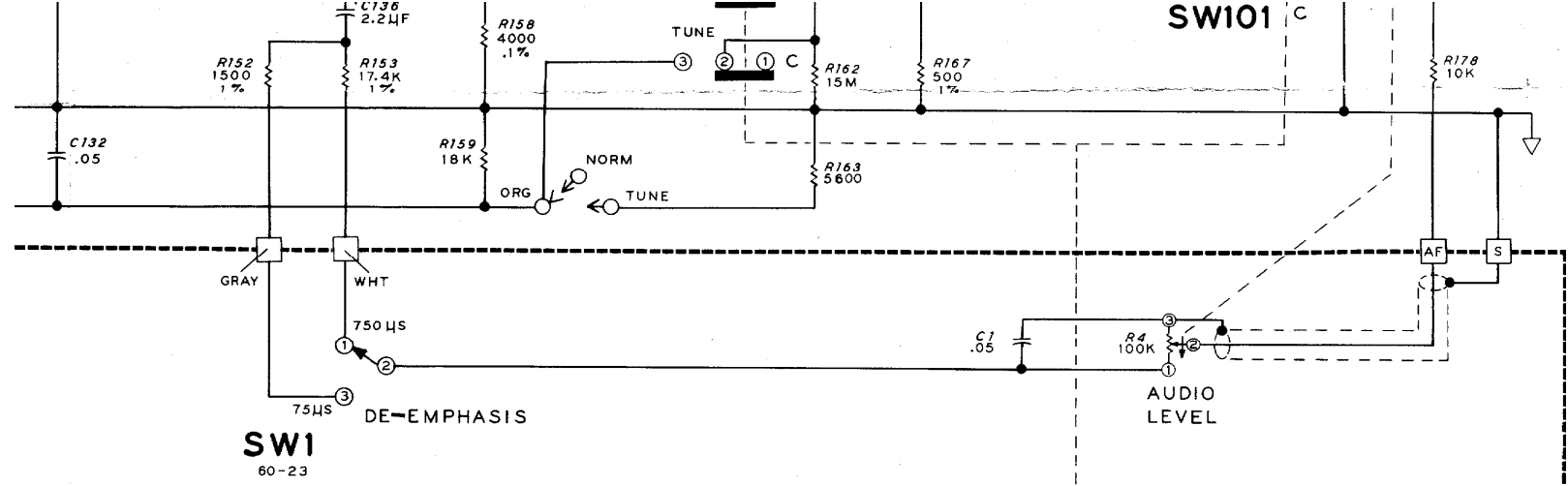

SW101

201-299 PARTS MOUNTED ON THE MAIN CIRCUIT BOARD

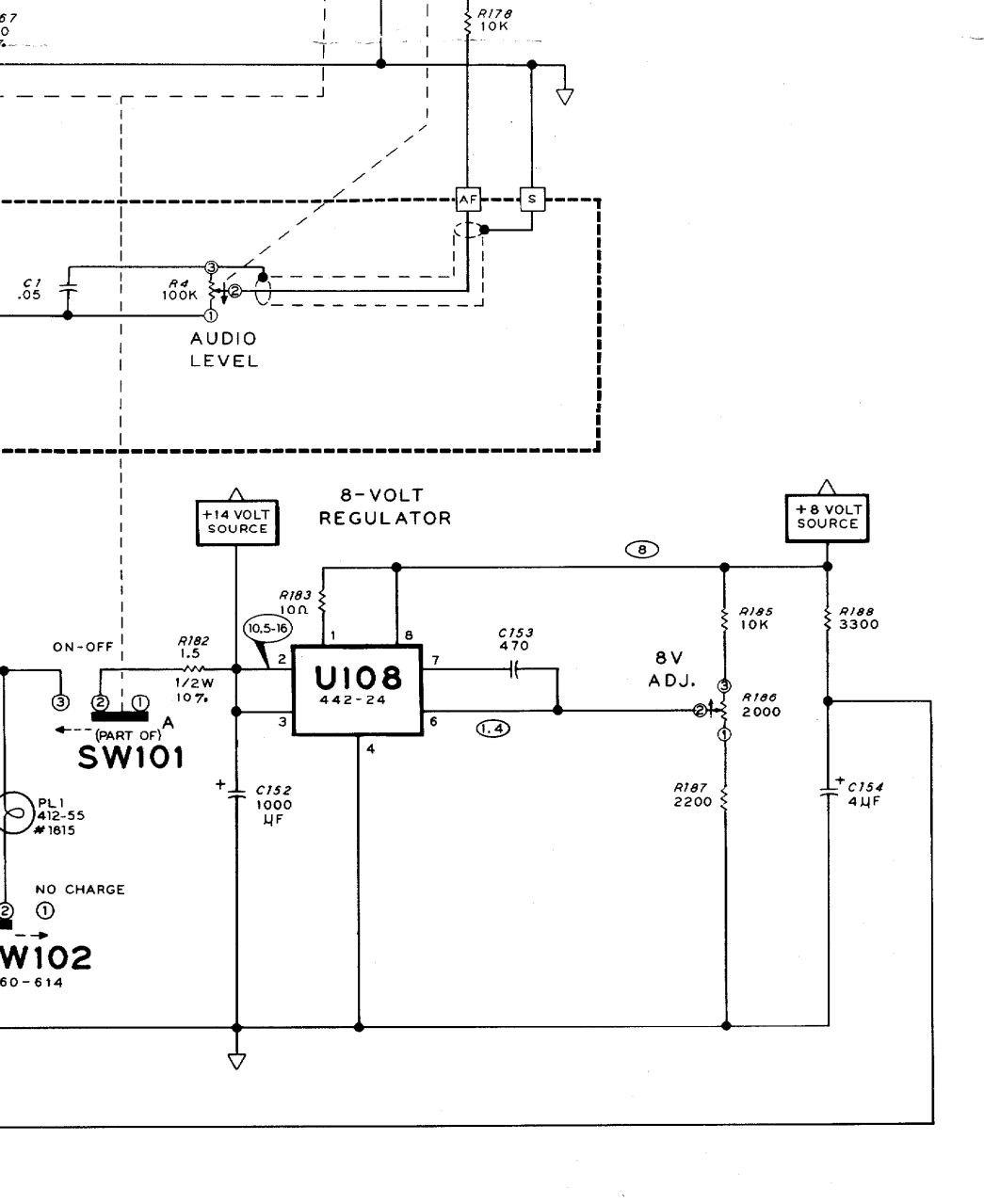

2. ALL RESISTORS ARE 1/4-WATT, 5% TOLERANCE UNLESS OTHERWISE MARKED.
3. CAPACITORS LESS THAN 1 ARE IN μF (MICROFARAD). CAPACITORS 1 OR GREATER ARE IN pF (PICOFARAD) UNLESS OTHERWISE MARKED.
4. THE FOLLOWING SYMBOLS ARE USED ON THIS SHEET:

- CIRCUIT BOARD GROUND.
- CHASSIS GROUND.
- DC VOLTAGE MEASUREMENT TAKEN WITH INPUT VOLTMETER FROM THE POINT INDICATED BY THE CIRCLE AND GROUND WITH NO SIGNAL INPUT. VOLTS.
- SIGNAL INPUT DC VOLTAGE. (SEE PREVIOUS PAGE).
- CIRCUIT BOARD WIRE CONNECTIONS, WIRE BONDING, AND SOLDER JOINTS.
- CIRCUIT BOARD CONNECTOR PINS AND (→) PIN, (←) FEMALE CONNECTOR.
- INDICATES A CLOCKWISE ROTATION OF A COMPONENT.
- INDICATES A CHASSIS-MOUNTED COMPONENT.
- BOLD LETTERS CORRESPOND TO TEST POINTS SHOWN ON THE SCHEMATIC DIAGRAM AT WHICH THE WAVEFORMS WERE TAKEN.

DEVIATION METER SETUP PROCEDURE IS AS FOLLOWS:







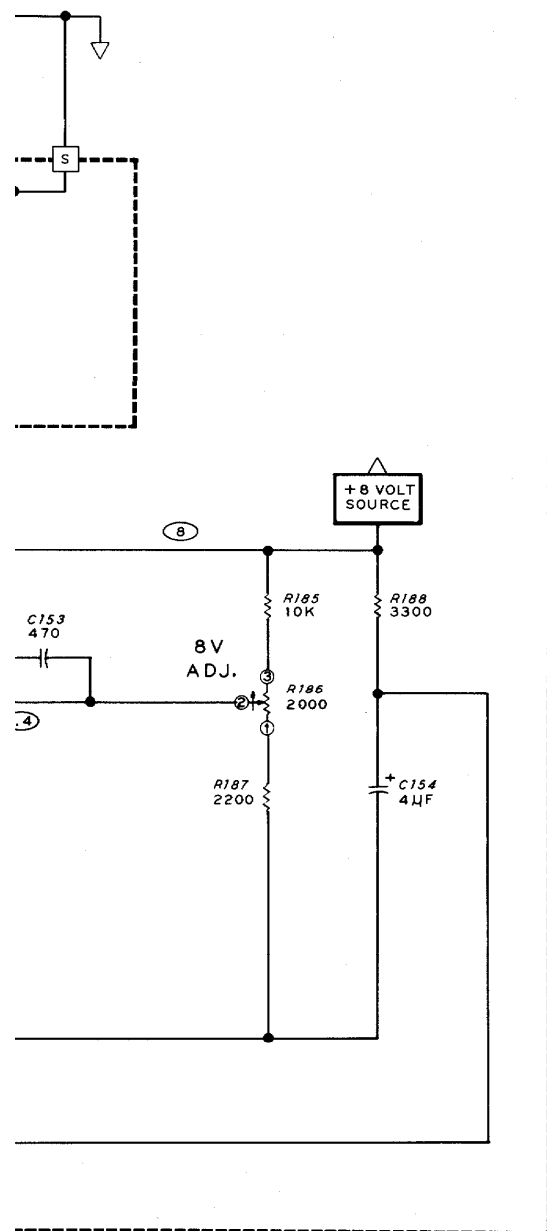

- INPUT CARRIER FREQUENCY: 200 KHZ
- DEVIATION FREQUENCY: 10 KHZ
- MODULATION FREQUENCY: 1000 HZ
- SIGNAL TUNED FOR FUNDAMENTAL DEVIATION METER WITH GAIN CONTROL FULL-SCALE METER READING.

5. CIRCUIT BOARD X-RAY VIEWS ARE SHOWN ON THIS SHEET PAGE 11.
6. OSCILLOSCOPE WAVEFORMS ARE SHOWN IN THE APPROPRIATE AREAS OF THIS SHEET.
7. SEMICONDUCTOR CHARTS ARE SHOWN ON PAGES 12 AND 13.
8. PUSHBUTTON SWITCH SW101 HAS SEVERAL SEGMENTS. SOME OF THE SEGMENTS ARE 2-PART, ARE NUMBERED, AND MAY BE SHOWN IN DIFFERENT AREAS OF THIS SHEET.
9. SWITCH SW101 IS SHOWN WITH ALL PUSHBUTTON RELEASED (OUT).

178
OK



2. ALL RESISTORS ARE 1/4-WATT, 5% TOLERANCE UNLESS OTHERWISE MARKED.
3. CAPACITORS LESS THAN 1 ARE IN μF (MICROFARADS). CAPACITORS 1 OR GREATER ARE IN pF (PICOFARADS) UNLESS OTHERWISE MARKED.
4. THE FOLLOWING SYMBOLS ARE USED ON THIS SCHEMATIC DIAGRAM.

-  CIRCUIT BOARD GROUND.
-  CHASSIS GROUND.
-  DC VOLTAGE MEASUREMENT TAKEN WITH A HIGH IMPEDANCE INPUT VOLTMETER FROM THE POINT INDICATED TO CHASSIS GROUND WITH NO SIGNAL INPUT. VOLTAGE MAY VARY $\pm 10\%$.
-  SIGNAL INPUT DC VOLTAGE. (SEE PREVIOUS NOTE.)
-  CIRCUIT BOARD WIRE CONNECTIONS, WIRE CALLED OUT.
-  CIRCUIT BOARD CONNECTOR PINS AND FEMALE WIRE JUMPERS (\rightarrow PIN, \leftarrow FEMALE CONNECTOR).
-  INDICATES A CLOCKWISE ROTATION OF A CONTROL.
-  INDICATES A CHASSIS-MOUNTED COMPONENT.
-  BOLD LETTERS CORRESPOND TO TEST POINTS ON THE SCHEMATIC DIAGRAM AT WHICH THE WAVEFORMS ARE MEASURED.

DEVIATION METER SETUP PROCEDURE TO OBTAIN THE WAVEFORMS IS AS FOLLOWS:

- INPUT CARRIER FREQUENCY: 25 MHZ.
- DEVIATION FREQUENCY: 5 KHZ.
- MODULATION FREQUENCY: 1 KHZ.

SIGNAL TUNED FOR FUNDAMENTAL FREQUENCY (25 MHZ) ON DEVIATION METER WITH GAIN CONTROL SET TO PRODUCE A FULL-SCALE METER READING.

5. CIRCUIT BOARD X-RAY VIEWS ARE SHOWN ON ILLUSTRATION BOOKLET PAGE 11.
6. OSCILLOSCOPE WAVEFORMS ARE SHOWN IN THE MANUAL ON PAGE 62 AND 63.
7. SEMICONDUCTOR CHARTS ARE SHOWN ON PAGES 60-61.
8. PUSHBUTTON SWITCH SW101 HAS SEVERAL SEGMENTS (A THROUGH G). SOME OF THE SEGMENTS ARE 2-PART, ARE NUMBERED 1-2-3 OR 4-5-6, AND MAY BE SHOWN IN DIFFERENT AREAS OF THE SCHEMATIC.
9. SWITCH SW101 IS SHOWN WITH ALL PUSHBUTTONS RELEASED (OUT).

HEATH

Schlumberger

HEATH COMPANY • BENTON HARBOR, MICHIGAN
THE WORLD'S FINEST ELECTRONIC EQUIPMENT IN KIT FORM

LITHO IN U.S.A.